

XR150FC/XR550FC USER GUIDE

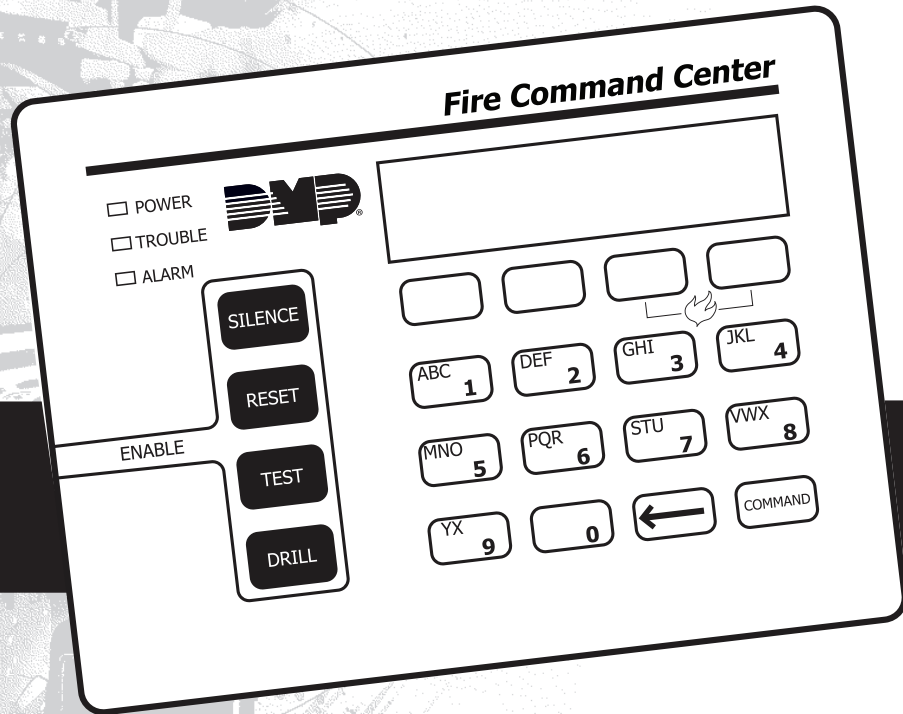

Silencing an Alarm

While the fire alarm horns, strobes, or sirens are sounding use one of the following methods to silence the alarm.

1. Turn the keyswitch to enable the four function keys. Then press the SILENCE key.

OR

2. Enter your user code. Then press COMMAND.

Note: You may silence an alarm using both of the above methods on the Remote Fire Command Center as well.

Copyright© 2013 Digital Monitoring Products, Inc.

Information furnished by DMP is believed to be accurate and reliable.

This information is subject to change without notice.

XR150FC/XR550FC User's Guide

Table of Contents

<i>Section</i>	<i>Page</i>	<i>Section</i>	<i>Page</i>
Emergency Evacuation Plans	1	Zone Status	11
Draw a floorplan of your home or business	1	System Status.....	12
Develop escape routes.....	1	System Test.....	13
Decide where to meet	1	User Profiles	14
Practice your escape plans.....	1	User Profiles Reference.....	14
Early detection	1	User Codes	16
Introduction	2	Extend Closing	18
About Your Fire Alarm Control Panel	2	Schedules.....	18
Fire Command Center.....	2	Setting Schedules.....	19
User Menu	2	Setting Holiday Dates (HOL)	21
The Fire Command Center	3	Setting the Date and Time	21
Using the Keypad	4	Ambush Codes.....	22
Four Function Keys.....	5	Display Events	22
Special Fire Command Center Displays.....	6	Service Request	22
Special Fire Command Center Tones	7	Fire Drill	22
Fire Command Center User Menu	8	Appendix A	23
Alarm Silence.....	9	About the Display Events Section.....	23
Sensor Reset.....	9	Zone Event Displays	24
Lockdown	9	User Code Change Event Displays	24
Door Lock/Unlock.....	9	Supervisory Event Displays	24
Door Access.....	10	Appendix B	26
Outputs On Off	10	Zone Status Browser	26
Favorite.....	11	Outputs On/Off Browser	27

Output Groups Browser	27
Change User Profiles Browser.....	28
Add User Codes Browser.....	28
Delete User Codes Browser	29
Change User Codes Browser	29
Entering User Names.....	30
Appendix C	31
Common Keypad Displays	31

Emergency Evacuation Plans

The National Fire Protection Association recommends that you establish an emergency evacuation plan to safeguard lives in the event of a fire or other emergency.

Draw a floorplan of your home or business

On a sheet of paper, draw the walls, windows, doors, and stairs. Also draw any obstacles, such as large furniture or appliances, a person may encounter while exiting the building.

Develop escape routes

Determine at least two routes the occupants in each room can take to safely escape. One route can be the most obvious such as the door. Another can be through a window that can be easily opened. If the window is high off the ground, an escape ladder should be provided. Draw arrows on the floorplan to show escape routes from each room.

Decide where to meet

Prearrange a meeting place outside and away from where emergency personnel are likely to be working. A neighbor's house or across the street in the front of the house are good locations. Always perform a head count to make sure all occupants safely exited. NEVER ENTER A BURNING BUILDING. If the head count shows one or more persons missing, give this information immediately to the authorities. Never enter a building to look for someone.

Practice your escape plans

Devising an escape plan is only the beginning, before the plan can be effective everyone should practice the escape routes from each room.

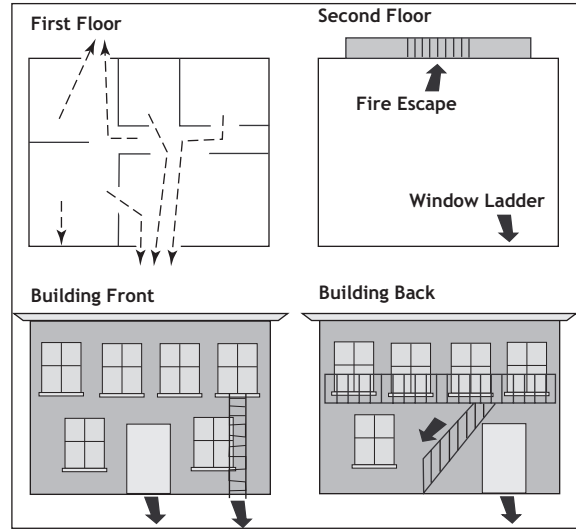

Early detection

The best way to survive a fire or other emergency is to get out early. The installation of a fire alarm system, with smoke and carbon monoxide detectors in each room, can greatly decrease your risk of loss or injury.

This page intentionally left blank

Introduction

About Your Fire Alarm Control Panel

The Fire Alarm Control Panel is designed with your safety and comfort in mind. It uses the latest in computer based technology to create the most advanced and user-friendly fire, security, and access control system available.

The Fire Alarm Control Panel combines ease-of-use with a simple-to-understand Fire Command Center display to offer the full range of features requested by today's fire system owners.

You can turn portions of your protection on or off at any time by pressing a few keys. You can add, delete, and change personal user codes at any time or check the status of protection devices in the system. An added feature of the Fire Alarm Control Panel is the membrane keyboard with four additional function keys you may use to easily perform a variety of functions.

Fire Command Center

The XR150FC/XR550FC comes with a built-in LCD display with a 20-key membrane keyboard called the Fire Command Center. The keyboard is mounted behind an opening in the red enclosure door. Use the keyboard to perform a variety of functions as listed in this User's Guide.

A Remote Fire Command Center is also available to use with the XR150FC/XR550FC Addressable Fire Alarm Control Panel. The remote keyboard can be placed anywhere throughout the premises.

Both keyboards have four additional function keys, to be used for alarm silencing, resetting smoke detectors, system testing, and performing fire drills. Both keyboards require the user to turn a keyswitch to enable the four function keys.

User Menu

The keyboards also provide access to the User Menu, which contains all of the functions necessary to fully operate your system.

The Fire Command Center

Your system comes equipped with a built-in, easy-to-use Fire Command Center that allows you to properly operate the system. The Command Center is also available in a remote version. The keyswitch to the left of the keyboard must be turned to the “enable” position before you can use the four functions keys. It is not necessary to use the keyswitch when using a user code to perform operations. The illustration and descriptions below highlight some features of the Fire Command Center:

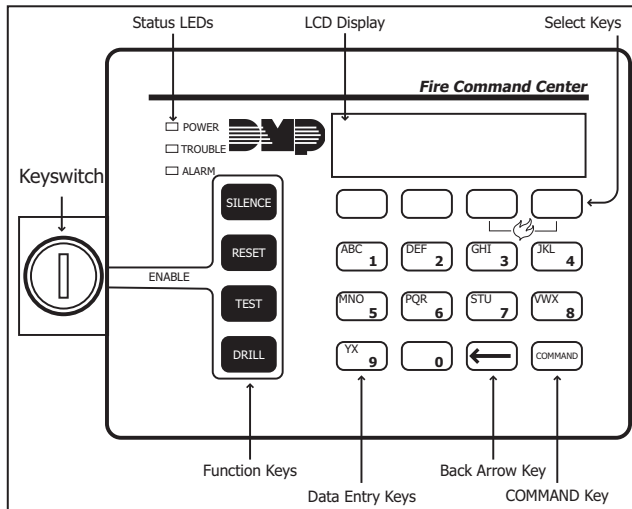

The Select keys

There are four keys under the display called the Select keys. They allow you to choose what to do by pressing the Select key under choices being shown in the display.

Data Entry keys

These keys allow you to enter your user code and other information into the system.

The Back Arrow key

Use the Back Arrow key to go back through displays while operating your system. Press the Back Arrow key to back up through the list of User Menu functions or to make a correction by erasing the last character you entered.

The COMMAND key

The COMMAND key allows you to advance through the displays or User Menu or complete a data entry function.

Status LEDs

The Fire Command Center incorporates three LEDs to indicate the system status. The three indicator lights are described below.

POWER LED

This LED remains ON steady when both AC and battery input are good. The LED turns OFF when AC input is low. The LED flashes at half-second intervals when battery input is low.

TROUBLE LED

This LED turns ON when any trouble displays in the status list, such as AC, battery, phone line, transmit, ground fault, NAC, or any zone trouble. This light is OFF when no trouble displays in the status list.

ALARM LED

The ALARM LED is ON when any alarm currently displays in the status list. This LED is OFF when no alarm currently displays in the status list.

Using the Keypad

Multi-lingual Display Option

Your system may be programmed to display the User Menu and Status Display text in multiple languages. When the COMMAND key is pressed, the option to choose the language displays. The language chosen continues to display at this keypad until another language is chosen.

Keypad Displays Current Programming

Most User Menu options displayed at the keypad show the currently selected option in the panel memory. These options are either shown as a number, a blank, or a **NO** or **YES**. To change a number press any top row Select key. The current option is replaced with a dash. Press the number(s) on the keypad you want to enter as the new number for that option.

It is not necessary to enter numbers with leading zeros. The panel automatically right justifies when you press the COMMAND key.

To change an option that requires a **NO** or **YES** response, press the top row Select key under the response not selected.

For example, if the current option is **YES** and you want to change it to **NO**, press the third top row Select key. The display changes to **NO**. Press the COMMAND key to go to the next option.

Multiple Displays

For many User Menu options on burglary keypads of combination burglary and fire systems, such as **Access Areas**, there are several displays containing lists. For example, in **Access Areas**, areas 1 through 32 display on four separate displays. First, areas 1 through 8 display. Press the COMMAND key to display areas 9 through 16. Press the COMMAND key again to display areas 17 through 25. Press the COMMAND key one more time to display areas 26 through 32.

Note: Only areas pre-programmed at installation can display.

Asterisks in Burglary Area Armed Displays

Asterisks display next to a programming option that is already selected. As shown in the example, options chosen to display the current programming selection have an asterisk next to the number. Those that are not selected simply display the number. In the example, Burglary Areas 3, 8, 9, 15, 19, 23, 25, and 31 are not selected. In both examples the numbers with asterisks are selected.

Burglary Areas

*1 *2 3 *4	*17 *18 19 *20
*5 *6 *7 8	*21 *22 23 *24
9 *10 *11 *12	25 *26 *27 *28
*13 *14 15 *16	*29 *30 31 *32

To select or deselect a number, simply enter the number using the digit keys on the keypad. This same scheme is used when viewing the panel armed status and other programming and operational functions. Remember to press the COMMAND key to display the rest of the device or area numbers.

User Options

The User Options allow you to make adjustments to your keypad to best fit your environment and needs.

To access the User Options portion of the keypad, press and hold the Back Arrow and COMMAND keys for two seconds. The keypad display changes to SET BRIGHTNESS. Press the COMMAND key to display the next option or the Back Arrow key to exit.

Backlighting Brightness

Sets the keypad LCD, and AC LED backlighting brightness level. At the SET BRIGHTNESS display, use the left Select key to lower the keypad brightness. Use the right Select key to increase the brightness.

Note: If the brightness level is lowered, it temporarily reverts back to maximum intensity whenever a key is pressed.

Internal Speaker Tone

Sets the keypad internal speaker tone. At the SET TONE display, use the top left Select key to make the tone lower. Use the right Select key to make the tone higher.

Volume level

Sets the keypad internal speaker volume level for key presses and prewarn conditions. During alarm, trouble, and prewarn conditions, the volume is always at maximum level. At SET VOLUME LEVEL, use the left Select key to lower the keypad volume. Use the right Select key to raise the volume.

Model Number

The keypad model number, firmware version, and date display, but cannot be changed.

Four Function Keys

The Fire Command Center is designed with four additional keys on the left side of the keypad. After turning the keyswitch, you can quickly perform vital functions using these four keys.

SILENCE Key

Pressing the SILENCE key silences the alarm bells.

RESET Key

Pressing the RESET key performs a sensor reset and silence the alarm bells.

TEST Key

Pressing the TEST key performs a system test.

DRILL Key

Pressing the DRILL key displays a prompt "SURE? YES NO". Press YES to begin the fire drill. Press NO to return to the status list.

Special Fire Command Center Displays

As you use your system, you occasionally see a display that asks you to enter a code or that describes a condition on the system. Below are some examples of the displays:

ALARM

A 24-hour zone (for example fire or panic) or an armed burglary zone has been tripped. Your system may sound bells or sirens.

ALARM NOT SENT (Burglary Keypad)

The alarm signal was not sent to the central station because a user code was entered to disarm the system before the alarm signal was sent to the central station.

ALARM CANCELLED (Burglary Keypad)

An Alarm Cancel signal was sent to the central station because a user code was entered after an alarm was sent to the central station.

SILENCED

An Alarm Silence has been performed to turn off the notification appliances. Zone names are displayed on the bottom line of the keypad display.

SUPVSRY (SUPERVISORY)

A Supervisory type zone alarm has occurred. The zone name is displayed on the bottom line of the keypad display.

TROUBLE

There is a problem with a protection device or system component. This display is accompanied by a description of the problem.

ENTER CODE

The system requires you to enter your user code. User codes can be required for turning your system on (arming), turning your system off (disarming), and many other functions.

As you enter your user code, the keypad display shows an asterisk (*) in place of each digit pressed. This keeps others from seeing your user code on the display as it is entered.

TRY AGAIN or INVALID CODE

The user code you have entered is not recognized by the system. Check the user code and try again.

INVALID PROFILE

All user codes have a profile that allow the user to only access certain functions. When users attempt functions outside their authority, the INVALID PROFILE message displays.

INVALID AREA

A user has attempted a door access for an area they are not assigned.

INVALID TIME

A user code assigned to a specific schedule is entered outside of the valid schedule. See Schedules and User Codes.

ARMED AREA

A user has attempted a door access to an armed area to which they do not have arming and disarming authority.

FAILED TO EXIT (ANTI-PASS BACK) (Burglary Keypad)

Anti-passback requires users to properly exit (egress) an area they have previously accessed. If they fail to exit through the proper card reader location they are not granted access on their next attempt. A Failed to Exit message appears when a user assigned the anti-passback option attempts to re-enter an area which they did not exit properly. The user must exit the area through the proper door. If not possible, your system administrator should select the Forgive option in the User Codes menu option.

SYSTEM TROUBLE or SERVICE REQUIRED

There is a problem with one or more of the components in your system. Contact our service department as soon as possible.

SYSTEM BUSY

The system is performing another task of a higher priority. This usually only takes a few moments.

Special Fire Command Center Tones

Your keypad also contains a small speaker that alerts you about events as they occur on your system. For an alarm, as soon as the first digit key is pressed to enter a user code, the tone stops. If no other keys are pressed for five seconds or an invalid code is entered, the tone turns on again.

Fire Alarm tone: An intermittent sweeping siren that sounds until the fire alarm is silenced.

Key press tone: A short beep each time you press a key on the keypad and it is acknowledged by the system.

Prewarn tone: A continuous pulsed tone that sounds when you open an entry delay door on a system that is armed (turned on) reminding you to disarm the protection. The tone silences as soon as the first user code digit key is pressed.

Exit tone: A continuous pulsing tone that sounds during the exit countdown just after arming to remind you to exit the premise. At ten seconds prior to the end of the countdown, the rate of pulsing increases.

Trouble tone: A steady tone indicating a trouble condition on your system. Press a Select key to silence.

What to do when the trouble tone sounds

You can silence the trouble tone by pressing any key. This only silences the keypad and does not correct the condition that originally caused the trouble.

User Menu

Fire Command Center User Menu

Many of your system features are included in a User Menu you can access from the Fire Command Center or the Remote Fire Command Center. The menu requires you to enter your user code and then only shows those functions to which you have access.

Some features displayed on the User Menu are not necessary for the XR150FC/XR550FC Addressable Fire Alarm Control Panel. Please disregard these prompts and displays. Press the COMMAND key to skip any displays and prompts not discussed in this User Guide.

Accessing the User Menu

1. Press the COMMAND key, if the multi-language option is enabled, the available languages display. Press the top row Select key under the language to use for text display.
2. Press the COMMAND key until MENU? NO YES displays.
3. Select YES. The keypad displays ENTER CODE: -. Enter your user code and press COMMAND. You can now scroll down through the list of system features available to you.

User Menu Options

The list below shows the User Menu options in the order they display.

Menu Option	Description
ALARM SILENCE	Silences an alarm bell or siren.
SENSOR RESET	Resets smoke or glassbreak detectors that have latched due to an alarm condition.
OUTPUTS ON/OFF	Allows you to turn on or off any of the outputs described in the System Setup section of this guide.

The following pages detail each user menu item and provide instructions on when and how to properly use them.

Alarm Silence

Silences the alarm bells or sirens during an alarm.

Alarm Silence allows you to turn off the alarm bells and sirens connected to your system during an alarm. Using Alarm Silence does NOT stop an alarm report from being sent to the central station and does not reset any alarmed devices. Use the Sensor Reset function to reset devices such as smoke detectors that latched in alarm.

Note: The keypad tone silences as soon as the first user code digit key is pressed. You can also silence an alarm by entering your user code and pressing COMMAND or by presenting your card to a reader while the Status List displays. If using a proximity card, areas assigned to your card may be disarmed and door access occurs.

Using the Alarm Silence Function

1. Access the User Menu.
2. The keypad displays ALARM SILENCE?.
3. Press any Select key to silence the bells and exit the User Menu.

Sensor Reset

Resets smoke or glassbreak detectors. Also clears Fire/Supervisory alarm and trouble displays.

Sensor Reset is used to reset smoke and glassbreak detectors after they have tripped. Once these detectors trip, they must be reset before they can detect any additional alarm conditions. When you select Sensor Reset, power to the detectors is temporarily removed by the system allowing them to reset.

Make sure all smoke is cleared from around the smoke detector areas before performing a Sensor Reset to prevent the alarm from occurring again.

Resetting the Sensors

1. Access the User Menu.
2. Press COMMAND until SENSOR RESET displays.
3. The keypad displays SENSORS OFF for five seconds followed by SENSORS ON.
4. The keypad automatically exits the User Menu.

Lockdown

Locks all Public Doors from the keypad in an emergency situation.

Using Lockdown

1. Access the User Menu.
2. Press COMMAND until LOCKDOWN? displays.
3. Press any Select key. The door access relay is activated and all Public Doors are locked.
4. Press COMMAND to return to the Status List display.

Door Lock/Unlock

Locks and unlocks doors from the keypad.

Using Door Lock/Unlock

1. Access the User Menu.
2. Press COMMAND until DOOR LOCK/UNLOCK? displays.
3. Enter the door number and press COMMAND.

-OR-

Press the fourth Select Key to browse door names. Use the COMMAND key to scroll through names and press any Select Key when the desired door is displayed.

4. Press the Back Arrow key to return to the DOOR LOCK/UNLOCK? display.

Door Access

Operates an electric door strike from the keypad.

Note: The door strike function is not available on Clear Touch™ keypads or the Model 7872 Graphic Touchscreen keypad.

Door Access is used to operate the door strike relay that is built into some keypads. Power for the door strike is connected to the keypad relay and can be interrupted by using the Door Access function.

When Status List displays, you can operate Door Access by simply entering your user code and pressing COMMAND. See Easy Entry™ User's Guide in Appendix E. If you are using a keypad that has a built-in card reader, you may simply present your card to be allowed Door Access.

Note: Your system may be pre-programmed at installation to transmit a door access report to the central station.

Using the Door Access

1. Access the User Menu.
2. Press COMMAND until DOOR ACCESS? displays.
3. Press any Select key. The door strike relay turns on momentarily.
4. The keypad returns to the Status List display.

Outputs On Off

Allows you to manually turn the system or door access relay outputs ON and OFF.

This function is used to individually turn your system relay and access door outputs ON and OFF. Your system may use these outputs to control door access, interior and exterior lighting, heating, air conditioning, or other appliances.

The names and numbers of the relays connected to your system are located in the System Setup section of this guide.

Outputs can be turned ON or OFF regardless of the output settings in Schedules.

Your system may be programmed to require that your user code profile have access to areas assigned to the keypad. INVALID AREA displays when your user code does not have access to the keypad's areas and the output does not turn on.

Under certain conditions, some outputs cannot be turned on. If you select a restricted output, the keypad displays CANNOT TURN ON.

Turning the Outputs ON and OFF

1. Access the User Menu.
2. Press COMMAND until OUTPUTS ON/OFF? displays.
3. Press any Select key to display OUTPUTS DOOR.
4. Select the type of output you want to turn ON or OFF by pressing the Select key under OUTPUTS or DOOR.
5. Enter the output number you want to turn ON or OFF. The output number displays. The range for outputs is 1-6, 500-999. The range for the door is 1-16.
6. With the output number displays, press the Select key under ON or OFF. The output then turns ON or OFF depending on your Selection, and remains in that state until you change it. The keypad displays the output or door name first 12 characters followed by either ON or OFF for four seconds to provide visual verification of the action. Press the COMMAND key to end the four second display.
7. The system automatically returns to the output or door prompt to allow you to select a new output to turn ON or OFF. Refer back to step 4.
8. Press the Back Arrow key to exit the User Menu.

Browser Feature

If you are unsure of the output number, refer to Appendix B at the back of this guide for a diagram showing you how to use the built-in Outputs ON/OFF browser.

Favorite

Allows you to activate a Z-Wave Favorite.

1. When FAVORITES? displays, press any Select key. The keypad displays FAVORITE: -.
2. Enter a Favorite number from 1-20. Pressing COMMAND activates the Favorite.

Zone Status

Displays a list of armed, bypassed, or alarmed zones. Also allows you to check individual zone status. Zone Status can be used to give you a list of zones by category or display the current status of an individual zone number. The four categories are:

- Armed Zones - zones that are currently armed.
- Bypassed Zones - zones that are currently bypassed.
- Alarmed Zones - zones that have gone into alarm during the current or previous armed period.
- Number - enter the number of any zone to check its status.

Using the Zone Status Function

1. Access the User Menu.
2. Press COMMAND until ZONE STATUS? displays.
3. Press any Select key to display ARM BYPS ALR NBR.
 - 3a. Select ARM for a list of zones that are currently armed. You can scroll through the list by pressing the COMMAND key.
 - 3b. Select BYPS for a list of zones that are currently bypassed.
 - 3c. Select ALR for a list of zones that have gone into alarm during the current or previous armed period.
 - 3d. Press NBR and ZONE NO: - displays.
4. At the ZONE NO: - prompt, enter the zone number you want to check and press COMMAND. The zone number and name display followed by the zone status. For example, a zone status for zone 1 might be BACK DOOR - OKAY.

Below is a list of the zone status displays:

- OKAY = the zone is in a normal condition
- BYPAS = the zone is bypassed
- BAD = the zone is in a bad or faulted condition

5. After displaying the zone status, ZONE: - returns for you to enter another zone number.

Browser Feature

If you are unsure of the zone number or description, refer to Appendix B at the back of this guide for a diagram showing you how to use the built-in Zone Status browser.

System Status

Displays the internal system hardware current condition.

System Status shows the panel condition of AC power, battery power, and optional panel tamper. When System Status is selected, each monitor displays followed by OKAY or TRBL (Trouble) to indicate the current condition.

Using the System Status Function

1. Access the User Menu.
2. Press COMMAND until SYSTEM STATUS? displays.
3. Press any Select key. The display starts listing each system monitor and status.

For example: AC POWER - OKAY

Below are the System Monitor displays:

Keypad Display	What it monitors
AC POWER	AC power
BATTERY	Battery power
TAMPER	Panel box tamper

These are followed by either OKAY or TRBL (trouble).

If TRBL displays, call the service department for assistance.

4. The system then displays its firmware version (for example, VER_103_10/18/13), the panel model (MODEL XR550DN), and then exits the User Menu.

System Test

System Test is used to test the battery, alarm bell or siren, and communication to a central station. The System Test function begins automatically as soon as you select it.

Using the System Test Function

1. Access the User Menu.
 2. Press COMMAND until SYSTEM TEST? displays.
 3. The keypad displays SYSTEM PANICS. Press the Select key below SYSTEM.
 4. The System Test begins automatically and the keypad displays the following messages in this order:
 - 1) **BELL SOUNDING** during a two second bell test
 - 2) **KEYPAD SOUNDING** all keypads assigned to the same area sound their alarm tone for two (2) seconds during the keypad sounder test
 - 3) **BATTERY - OKAY** or **BATTERY - TRBL** to indicate the battery condition
 - 4)* **TRANSMIT TEST** and **ATTEMPT NO: 1** during the transmit test
 - 5) **TRANSMIT OKAY** or **TRANSMIT FAILED** to show the results of the transmit test
 - 6) **TEST END** to indicate the System Test is complete.
 - 7) You can press the Back Arrow key to end the transmit test.
- * The transmit test does not occur on local systems.

Using the Panic Zone Test (XR550DNFC with Network/Encryption)

1. Access the User Menu.
2. Press COMMAND until SYSTEM TEST? displays.
3. Press any Select key. The keypad displays SYSTEM PANICS.
4. Press the Select key below PANICS.
5. The Panic Zone Test begins automatically and the keypad displays TRIPS: END.

During the Panic Zone Test, trip each panic zone (or button) on the system by pressing and holding the panic for 1 to 2 seconds.

Note: You do NOT have to hold the panic for 2 seconds in normal mode. You are only required to hold the panic during the Panic Zone Test because the zone takes additional time to report when the system is in test mode.

Each time you trip a panic zone, the display number increments and the keypad buzzer sounds for two seconds.

The number of panic zones tripped constantly displays until the test ends or no panic zone activity has occurred for 20 minutes.

6. Press the Select key below END to stop the Panic Zone Test.
7. PANIC TEST OKAY displays when the Panic Zone Test is completed and all zones tested OK.
8. When the Panic Zone Test ends and a zone failed (did not trip) during the test, the keypad displays the zone name and number and the buzzer sounds for one second. Press the COMMAND key to display the next failed zone.

Note: During the Panic Zone Test, any zones that fail are not sent to the receiver unless pre-programmed at installation to be sent.

User Profiles

Change User Profiles, that define the authority of each user code in the system. Several characteristics define the authority of each User Profile within the system.

Profile Number - Each profile may be assigned a unique number from 1 to 99.

Profile Name - Each profile may be assigned a 16-character name. The Profile Number is the default name.

Arm or Disarm Areas - Each profile may be assigned specific areas of the system for arming and disarming. When profiles 1 to 98 are created, NO areas are assigned by default. The default for profile 99 is ALL areas assigned. Profile 99 is predefined in the system by the factory.

Access Areas - Each profile may be assigned door access area assignments. Default for profile 1 to 98 is NO areas assigned. Default for profile 99 is ALL areas assigned. Profile 99 is predefined at the factory.

Output Group Assignment - Each profile may be assigned an output group number from 1 to 10. Default for profile 1 to 98 is NO output group assigned. Default for profile 99 is output group 10. Your system may be programmed to turn on an output group at certain keypads when door access occurs.

User Menu Assignments - Each user profile may have any of the menus assigned to it as shown in the User Profile Record below. The User Profile Record lists the user menu profile assignments and the system functions users are allowed to access based on the profile numbers assigned to their codes.

Always make sure that at least one administrator in your system has a profile with **all** authorities and **all** areas.

User Profiles Reference

Menu Display			Privilege
ARM	NO	YES	Arm
DIS	NO	YES	Disarm
ALM SLNC	NO	YES	Alarm Silence
SNSR RST	NO	YES	Sensor Reset
LOCKDOWN	NO	YES	Lockdown
DOOR LOCK/UNLOCK	NO	YES	Door Lock/Unlock
DOOR ACS	NO	YES	Door Access
ARM AREA	NO	YES	Armed Areas
OUTPUTS	NO	YES	Outputs ON/OFF
FAVORITES	F01- F20		Z-Wave Favorites
ZN STATS	NO	YES	Zone Status
BYPAS ZN	NO	YES	Bypass Zones
ZONE MON	NO	YES	Zone Monitor
SYS STAT	NO	YES	System Status
SYS TEST	NO	YES	System Test
PROFILES	NO	YES	User Profiles
USR CODE	NO	YES	User Codes
SCHEDULS	NO	YES	Schedules
TIME	NO	YES	Time
DIS EVNT	NO	YES	Display Events
SERV REQ	NO	YES	Service Request
FIRE DRILL	NO	YES	Fire Drill
EXTEND	NO	YES	Extend Schedules
TEMP CODE	NO	YES	Temporary User Code
ANTI PASS	NO	YES	Anti-Passback
ACCESS SCHEDULES	Sch. 1-99		Allow: Shift/Time Access
RE ARM DLY	0 – 720		Re-Arm Delay
SEC LANGUAGE	NO	YES	Preferred Language

Changing User Profiles

1. Access the User Menu.
2. Press **COMMAND** until **USER PROFILES?** displays.
3. Press any Select key. The keypad displays **ADD DEL CHG**.
4. Press the far right Select key, under **CHG**.
5. At the **PROFILE NO:** - option, enter a profile number and press **COMMAND**. The display changes to **PROFILE NAME**.
6. Press any Select key to display -. Enter a profile name of up to 16 characters. The default Profile Name uses the Profile Number. Enter the name and press **COMMAND**.
7. At the **Arm/Dis AREAS:** option, enter the area numbers (1-32) for arming and disarming assigned to this profile.
8. The keypad displays **ACCESS Areas:** . Enter the area numbers (1-32) assignment to allow door access for this profile. Press the **COMMAND** key.
9. The keypad displays **OUTPUT GROUP:** -. Enter the number (1 through 20) for the Output Group assigned to this profile. Press the **COMMAND** key.
10. The keypad displays each of the menus as shown in the Profile Table. You then enable or disable the menu function for this profile number. Select **YES** or **NO** and press the **COMMAND** key to advance to the next menu selection.
11. When you complete Selecting all User Profile menu assignments, the keypad displays the **PROFILE CHNGD** message for 4 seconds, indicating the profile is changed.

TEMP CODE

When you select **YES** for this menu option, and this profile is assigned to a user code (see next section), the keypad displays **TEMP EXPIRE DATE:**. Enter the ending date for the profile to expire. Default is seven days from today. The system deletes Temp users at 12:00 AM on the last date.

ANTI PASS NO

Anti-passback requires that you properly exit (egress) an area previously accessed. When you fail to exit through the proper location you cannot access it until you properly exit. Default is No. See page 6 for more information.

ACCESS SCHEDULES

This option allows you to assign two Schedules to a profile for door access. When the keypad displays **FIRST ACCESS SCHEDULE:**

- press **COMMAND** to browse available Schedules. Enter the Schedule number and press **COMMAND**. When the keypad displays **SECOND ACCESS SCHEDULE:** - repeat the same process for the third through eighth access schedule and press **COMMAND** to return to the User Menu.

RE ARM DELAY

RE ARM DELAY allows the entry of 0 to 720 minutes to be used to delay automatic rearming when the user disarms an area outside of schedule. If zero is selected, the rearming occurs based on permanent programming in the panel.

RE ARM DELAY is also used to delay a late to close message to the central station when the panel does not use automatic arming.

If the user has Extend Schedule authority, 2HR 4HR 6HR 8HR displays at disarming. If the user does not make a choice, the **RE ARM DELAY** is used to extend the schedule.

Application example: An exit door near the trash is scheduled to be armed at all times. When the custodian needs to remove trash, program 10 minutes for the activity. Or, an overhead door only requires access when a delivery is made. Program up to 250 minutes to allow the loading dock supervisor to load or unload a semi-truck.

Browser Feature

Refer to Appendix B in this guide for a diagram showing you how to use the Output Group browser and the Profile browsers.

User Codes

This option allows you to add, delete, or change a user code. You may also assign specific User Profiles to individual users.

3848	=	User Number
34812	=	User Code
John Smith	=	User Name
7	=	Profile

User Number - Every user is numbered 1 through 9999. This number identifies the user to the system and is transmitted to the central station when the user arms or disarms areas.

User Code - Each user also has a 3 to 6 digit code, to enter into the LCD keypad when arming or disarming the system.

Note: A User Code cannot begin with zero and 3-digit codes cannot begin with 98.

User Names - Each code may also be programmed with the user name. You may enter up to 16 characters for the name.

User Profile - The user is also assigned a Profile (1 to 99) by the person administrating the system. The profile number determines the areas and functions the user can access.

Note: Your system must have at least one user with user code authority in order to be able to add or delete user codes. Be careful not to delete all users with user code authority from your system.

Adding User Codes

1. Access the User Menu.
2. Press COMMAND until USER CODES? displays.
3. Press any Select key. The keypad displays ADD DEL CHG BAT.
4. Press the Select key under ADD or BAT (Batch) to add a new user code.
5. At the USER NUMBER: - prompt, enter a user number and press COMMAND. The display changes to USER CODE: - .
Note: Do NOT program a code for user number 1 unless you intend to use the Ambush function, see Ambush on page 17.
6. Enter a user code of 3 to 6 digits and press COMMAND. The user enters this number to arm, disarm, etc. After entering the code the keypad displays USER NUMBER ### as the user name.
7. A 16-character name may be entered to identify the user. Press any top row key to clear the current name. You may then enter the new name. After entering the name press COMMAND. See Entering Names in Appendix B.
8. The display changes to PROFILE NO: -. Select the profile number to assign a set of authorized functions to the user code as outlined in the Profile Table on the previous page.
9. At the PROFILE NO: - display, enter a profile number from 1 to 99, and press COMMAND. The displays shows USER # ADDED.

If BAT (Batch) was chosen in step 4 instead of ADD, the next available user number is automatically selected and only steps 6 and 7 repeat. The User Profile assignment is automatically selected for the next user based on the previous user entered. This batch entry method speeds up user entry in large systems.

Deleting User Codes

To delete a user code, you must have a user code with a profile that has user code authority.

1. Access the User Menu.
2. Press COMMAND until USER CODES? displays.
3. Press any Select key. The keypad displays
ADD DEL CHG BAT.
4. Press the second Select key, under DEL, to delete a user code from the system. To delete a user code, you must have a user code with a profile that has user code authority.

Note: Be careful not to delete all users with user code authority from your system. Also, the user code used to enter the user menu to delete codes cannot be deleted. In other words, you can not delete yourself.

5. At the USER NUMBER: - prompt, enter the user number you want to delete and press COMMAND. The display changes to
USER # DELETED.
6. The display then changes back to USER NUMBER: - allowing you to delete another user. Press the Back Arrow key twice to exit the User Menu.

Changing User Codes

1. Access the User Menu.
2. Press the COMMAND key until USER CODES? displays.
3. Press any Select key. The keypad displays
ADD DEL CHG BAT.
4. Press the third Select key, under CHG, to change a user code.
5. At the USER NUMBER: - prompt, enter the user number to change and press COMMAND.
6. The display changes to CODE NO: * * * * *. Press a Select key and enter the new user code. Press COMMAND.

Note: Changing a user code does not change the user number.

7. The display then shows the current user name. Press any top row key to clear. See Entering Names in Appendix B to enter a new name.
8. The display changes to PROFILE NO: -. Select the profile number to assign a set of authorized functions to the user code as outlined in the Profile Table on page 11.
9. After entering the profile number, the keypad displays
USER # CHANGED for 5 seconds followed by
USER NUMBER: -. This display allows you to change another user code. Press the Back Arrow key twice to exit the User Menu.

Browser Feature

Refer to Appendix B for diagrams showing you how to use the User Codes Add, Delete, and Change browsers.

Extend Closing

Extending schedules (EXT) allows the Closing Check operation to delay until the new closing time expires. This allows the current schedule to ignore its closing time and not send a LATE TO CLOSE message to the central station. This function is designed to allow workers to stay later and does not extend door access authority. The extended schedule erases when it expires.

1. Press any top row Select Key at the SCHEDULES option to view OUT DOOR HOL EXT. Select EXT to program Extended Schedules.
2. If Area Schedules are set to YES in Area Information you are prompted to enter the Area for which you wish to extend the closing time. Press any Select Key to browse Area names and press COMMAND at the chosen Area.
3. The keypad displays -: AM PM. Enter a time to extend the current Closing Check open period. Press COMMAND to exit the menu.

Note: If the system is not armed by the scheduled closing time, a Late to Close report is sent to the central station. If the schedule is extended, a Schedule Change report is sent to the central station.

Schedules

Schedules are ideal for individual area auto arming and disarming and for creating Opening/Closing windows during which users can access the building or disarm the system.

The Schedules function allows you to program into the system the times at which you normally turn your burglary protection on and off each day of the week. Your system may be pre-programmed at installation to allow automatic arming and disarming. When pre-programmed, you can enter a schedule for the arming and disarming times.

If your system does not use automatic arming, you can use the Closing Check/Extend feature with Schedules to help ensure your system is armed manually at a specific time. This option sounds the keypad buzzer and displays CLOSING TIME! or AREA LATE! when a schedule expires. This reminds users still on the premises to arm the system or extend the schedule to a later time.

Your system provides you with the following schedules menus:

1. **Times** allows you to create schedules 01-99 with days of the week, begin/end times, and holidays.
2. **Areas** allows you to assign areas to pre-programmed schedules set in the TIMES menu.
3. **Door** allows you to choose doors to assign schedules set in the TIMES menu.
4. **Output** allows you to choose an output to schedules set in the TIMES menu.
5. **Holiday** dates allow you to enter special dates that activate Holiday Schedules that supersede all other schedules.
6. **Favorites** allows you to activate a Z-Wave Favorite (1-20).

Setting Schedules

1. Access the User Menu and press COMMAND until SCHEDULES? displays. Press any Select key.
2. The keypad displays TIMES AREAS DOOR. Press COMMAND to display OUTPUT HOLIDAYS. Select the function you want to program.

TIMES

The keypad displays ADD DEL CHG.

Adding a Schedule

Select ADD to enter a new schedule number.

1. Enter the Schedule number 01-99 that you want to add. Press the COMMAND key to accept your Selection. You are then given the option to enter a Schedule name. Press COMMAND to proceed.
2. The keypad displays SUN MON TUE WED. Press the COMMAND key to display THU FRI SAT HOL. Select the day you want the schedule to begin. If you select HOL, go to Setting Holiday ABC Schedules for additional instructions.
Note: After Selecting the day of the week or holiday for the schedule to begin, the keypad displays any currently programmed Begin and End times previously set for that day. This feature allows you to review programmed schedules at any time.
3. If Begin and End times already exist, the keypad then displays DELETE KEEP. Select DELETE to enter new times.
4. The keypad then displays BEGIN TIME? followed by the display MON - : AM PM. Enter the new opening time and select AM or PM.

Enter all schedule times using a 12 hour clock. For example, to enter 6 AM you would enter a 0 + 6 + 0 + 0 and select AM.

For 11 PM you would enter a 1 + 1 + 0 + 0 and select PM.

The keypad then displays END TIME? followed by the display MON - : AM PM. Enter the new closing time and select AM or PM. Select whichever day displays, for example, MON, allows you to scroll through the days of the week and create a schedule window that spans multiple days.

Note: You must enter a Begin and End time or the system will not recognize the schedule.

The new schedule is now programmed into your system.

5. The keypad goes back to the SUN MON TUE WED display. Press the Back Arrow key to enter another schedule.
6. To clear a schedule press DELETE and then AM when the opening time is requested.
Press the Back Arrow key to exit the User Menu.

Delete a Schedule

Select DEL to delete a schedule number.

1. Enter the Schedule number 01-99 that you want to delete.
2. The keypad displays DELETE SCHEDULE SURE? YES NO. Select YES to delete the schedule.
3. The keypad displays SCHEDULE NO: - DELETED and the keypad prompts you for the next schedule number to be deleted.
Press the Back Arrow key to exit the User Menu.

Change a Schedule

Select CHG to edit an existing schedule.

1. Enter the schedule number 01-99 that you want to change.
2. The keypad displays ENTER SCHEDULE and the schedule name. To edit the name press any Select key to make changes. Press COMMAND to proceed.

3. The keypad displays SELECT WEEK DAY and SUN MON TUE WED. Press the COMMAND key to display THU FRI SAT HOL.
4. Enter the Begin and End times for each day of the schedule. Refer to Adding a Schedule for more information.
5. The keypad goes back to the SUN MON TUE WED display. Press the Back Arrow key to enter another schedule. Press the Back Arrow key to exit the User Menu.

Setting Area, Output, and Door Schedules

The Schedules function allows you to assign up to 8 different schedule numbers to each area, output, and door access relay connected to your system. The schedule number allows the opening and closing times for the area and on/off times for outputs and door access relays

1. Access the User Menu.
2. Press COMMAND until SCHEDULES? displays.
3. After you have accessed the SCHEDULES? menu and the schedule options, TIMES AREAS DOOR, display, press the COMMAND key once more and the display changes to OUTPUT HOLIDAYS. Select AREAS, DOOR, or OUTPUT.
4. The keypad displays ENTER THE AREA/OUTPUT/DOOR NUMBER:- , enter the area, output, or door number you want to assign a schedule. Press the COMMAND key.
5. The keypad displays SCHEDULE NO: -. Press any Select key and enter the schedule number (01 to 99). Press the COMMAND key.
6. The keypad returns to the TIMES AREAS DOOR display allowing you to enter additional programming. To exit the user menu press the Back Arrow key.

Setting Holiday ABC Schedules

Three Holiday Schedules are available. This allows an output, area, or door to have three different schedules for holidays. For example, Holiday Schedule A for those holidays when the building stays closed, Holiday Schedule B for a day that only opens for a morning, etc. Also, Holiday Schedules can be used to cross multiple days. These schedules become active and supersede the current day's schedule when a Holiday Date occurs. See Setting Holiday Dates (HOL).

1. After you have accessed the SCHEDULES? menu and the schedule options, TIMES AREAS DOOR, display, press the COMMAND key until the display changes to OUTPUT HOLIDAYS. Press COMMAND once more and the display changes to FAVORITES.
2. Select HOLIDAY to program holiday schedules.
3. The keypad displays HOL: A B C . Select A to set the first of three holiday schedules.
4. The keypad displays A - : AM PM.
Note: After Selecting the schedule, the keypad displays any current times previously set for that holiday. This feature allows you to review the programmed times.
5. If times display, the keypad then displays DELETE KEEP. Select DELETE to enter new times.
6. The keypad then displays BEGIN TIME? This is followed by the display - : AM PM.
 Enter a new time and select AM or PM.
 The display changes to END TIME? This is followed by the display - : AM PM.
 Enter a new time.

Enter all schedule times using a 12 hour clock. For example, to enter 6 AM you would enter 0 + 6 + 0 + 0 select AM. For 11 PM you would enter 1 + 1 + 0 + 0 and select PM.

7. The keypad returns to HOL: A B C allowing you to enter A B and/or C holiday schedule for the same Output or Door. Go back to step 3 to add additional holiday schedules.

Setting Holiday Dates (HOL)

Setting Holiday Dates provides the system with dates in the year when the normal opening and closing schedules are not used and superseded by one of the Holiday Schedules A or B or C. When the panel determines that it is a holiday, the Holiday Schedule supersedes the current schedule for that day. Up to fourty different holiday dates can be entered.

1. After you access the SCHEDULES? menu and the schedule options, TIMES AREAS DOOR, display, press the COMMAND key once more. The display changes to OUTPUT HOLIDAY FAVORITES. Select Holiday to program Holiday dates.
2. The keypad display changes to HOL: xx mm/dd A. You can now enter the month and day for the first holiday. Select A to change to HOL B. Pressing again changes to HOL C. Example: July fourth would be entered by pressing the 0704 keys. The keypad displays HOL:1 07/04 B.
3. To step to the next holiday number, press COMMAND. To clear a holiday press any top row Select key when the appropriate holiday number displays. Press the Back Arrow key when HOL: 1 or the COMMAND key when HOL: 40 displays to exit the menu.

Note: The Holiday Dates entered indicate the days of the year when HOL schedules are used. For information on setting holiday schedules for Area, Output, and Door, see Setting Holiday ABC Schedules.

Setting the Date and Time

Allows you to change the current date and time displayed on the LCD keypad and used by the system.

Setting the System Date and Time

1. Access the User Menu.
2. Press COMMAND until TIME? displays. Press any Select key.
3. The keypad displays the current day and time. Press the COMMAND key. The keypad displays the current date. Press the COMMAND key to make any changes.
4. The keypad displays TIME DAY DATE.
5. Press the Select key under TIME to change the time. The keypad displays - : AM PM. Enter the current time and select AM or PM. The display changes back to TIME DAY DATE.
6. Press the Select key under DAY to change the day of week. The keypad displays SUN MON TUE WED. Press the COMMAND key to display THU FRI SAT. Press the Select key under the correct day. Use the Back Arrow key to toggle between the different day of the week displays.
7. Press the Select key under DATE to change the date. The keypad displays

MONTH:- Enter up to 2 digits for the month.
Press COMMAND.

DAY:- Enter up to 2 digits for the day.
Press COMMAND.

YEAR:- Enter up to 2 digits for the year.
Press COMMAND.

The display returns to the TIME DAY DATE display.
Press the Back Arrow key to exit the User Menu.

Ambush Codes

Your system may be programmed to allow user number 1 to be used as an Ambush code. This Ambush code functions identically to a standard code with the exception that it sends a silent alarm to the central station. This silent alarm alerts the operator to a duress situation at the premises and prompts immediate notification of authorities.

Refer to the System Setup section of this guide to see if your system is programmed for Ambush. If so, do NOT program a code for user number 1 unless you intend to use the Ambush function.

Display Events

Allows you to review up to 12,000 past door access and system events. There are six event types:

Zone Activity - Zone alarms, troubles, and restorals.

User Code - Adding, deleting, and changing user codes.

Supervisory - Problems with system hardware components.

System Monitor- Problems with AC Power, Battery, phone line or tamper problems.

The system memory holds a maximum of 12,000 past events for 45 days. Any event older than 45 days automatically clears from the system memory. Also, once the full 12,000 events are stored, any new event causes the oldest event to be cleared. See Appendix A for Display Events.

Service Request

Your user code profile may be programmed for Service Request. This User Menu feature allows you to simply press any top row Select key when SERVICE REQUEST? displays and have the system automatically send a "Request for Service" message to the central station. The display changes momentarily to REQUEST MADE to confirm your request was sent.

Fire Drill

Fire Drill is used to test the fire bells or fire horns in your system. The Fire Drill test turns your system bell circuit on, but does not send a message to the central station.

Starting a Fire Drill test

1. Access the User Menu.
2. Press COMMAND until FIRE DRILL? displays. Press any Select key.
3. The keypad displays SURE? YES NO.
4. Press the Select key under YES to start the Fire Drill test.

Ending a Fire Drill test

1. Enter your code at the keypad and press COMMAND to end the Fire Drill.
2. The Fire Drill test automatically ends with ALARM SILENCE or the programmed Bell Cutoff time.

Appendix A

About the Display Events Section

This section of the User's Guide shows the Display Events items. While in the Display Events function, use the COMMAND and Back Arrow keys to go forward or backward through the list of events.

The system memory holds a maximum of 12,000 past events for 45 days. Any event older than 45 days automatically clears from the system memory. Also, once the full 12,000 events are stored, any new event causes the oldest event to be cleared. See Appendix A for Display Events.

To view more information about each display, press the Select key as directed in the explanations.

Using the Display Events

1. Access the User Menu.
2. Press the COMMAND key until DISPLAY EVENTS? displays. Press any Select key.
3. The keypad displays FRST LST PRT SRT. Select FRST (first) to view the oldest to newest events. Select LST (last) to view the newest to oldest events. If you select FIRST, use the COMMAND key to scroll up through the events. If you select LAST, use the Back Arrow key to scroll down through the events.
Select SRT to sort through the Display Events log and collect information specific to a user or system event.
Select PRT to print the complete Display Events log.
4. To use the Sort feature, press the Select key under SRT. The keypad displays FRST DATE: 8/21. Press any Select key and enter a 4-digit beginning date for the sort. Press COMMAND.

5. The keypad displays LAST DATE: 10/17. Press any Select key and enter a 4-digit ending date for the sort. Press COMMAND.
6. The keypad displays USER NUMBER: - . To sort events for a particular user, enter their user number or press COMMAND to sort for all users. To search for a user, press any Select key then use the COMMAND and Back Arrow keys to browse through the user names in the system. When the user you want displays, press any Select key then press COMMAND.
7. The keypad next displays five event types that you can include in the sort. Press the fourth Select key to display YES as the event type name displays on the keypad. Press COMMAND. The following are the five sort event types:
ACCESSES = door accesses granted.
DOOR NUMBER = leave blank for all doors.
Note: If you select yes for access then only Door Access Granted Events are included in the sort.
ZONE EVENTS = zone alarms, troubles, and restorals.
USER EVENTS = adding, deleting, and changing user codes.
SUPERVISORY = system hardware problems and door access denied events.
8. After the last event type displays, the keypad again displays FRST LST PRT SRT. You can now view or print the sorted Display Events or press SRT to define a new sort.

Zone Event Displays

This displays alarms, troubles, and other events that may occur on your protection zones.

32-Character Display

ALR	10:23P	10/17
BASEMENT DOOR		

Description

An alarm occurred at 10:23 PM on Oct. 17. Press any Select key to see the zone number and zone type.

Zone Type - There are seven possible zone types you may see here.

FIRE - Fire **PANC** - Panic **BURG** - Burglary
EMRG - Emergency **SUPV** - Supervisory
AUX1 - Auxiliary 1 **AUX2** - Auxiliary 2

Event Types - There are seven event type you may see here:

ALR - Alarm **TBL** - Trouble **RST** - Restore
FLT - Zone Fault **SVC** - Service smoke detector
LOW - Low battery **MIS** - Missing wireless transmitter

Note: LOW and MIS are for wireless systems only.

User Code Change Event Displays

This displays any addition, deletion, or change to a user code.

32-Character Display

ADD	11:41A	10/17
U:19	BY	U:12

Description

User 19 added by user 12 at 11:41 AM. Press the Select key under either user (US:) number for the user name.

User Code Event Types - There are three event type you may see here:

ADD - User added **DEL** - User deleted
CHG - User code or authority level changed.

Supervisory Event Displays

This displays the date and time of an automatic test report.

32-Character Display

MSG	11:58P	10/17
AUTO RECALL		

Description

The test report was sent to the central station at the date and time shown.

System Monitor Event Displays

This displays any problems with the system AC power, battery, or phone line(s), or any opening of a tampered panel box.

32-Character Display

TBL 11:41A 10/ 17 POWER

Description

An AC failure occurred at 11:41 AM. on Oct. 17.

System Monitor Event Types - There are 2 event types:

TBL - Trouble

RST - Restore System Monitor

Event Names - There are 5 system monitors:

POWER - AC power to panel

BATTERY - On panel

LINE 1 - Phone line number 1

LINE 2 - Phone line number 2

TAMPER - On panel box

Appendix B

Zone Status Browser

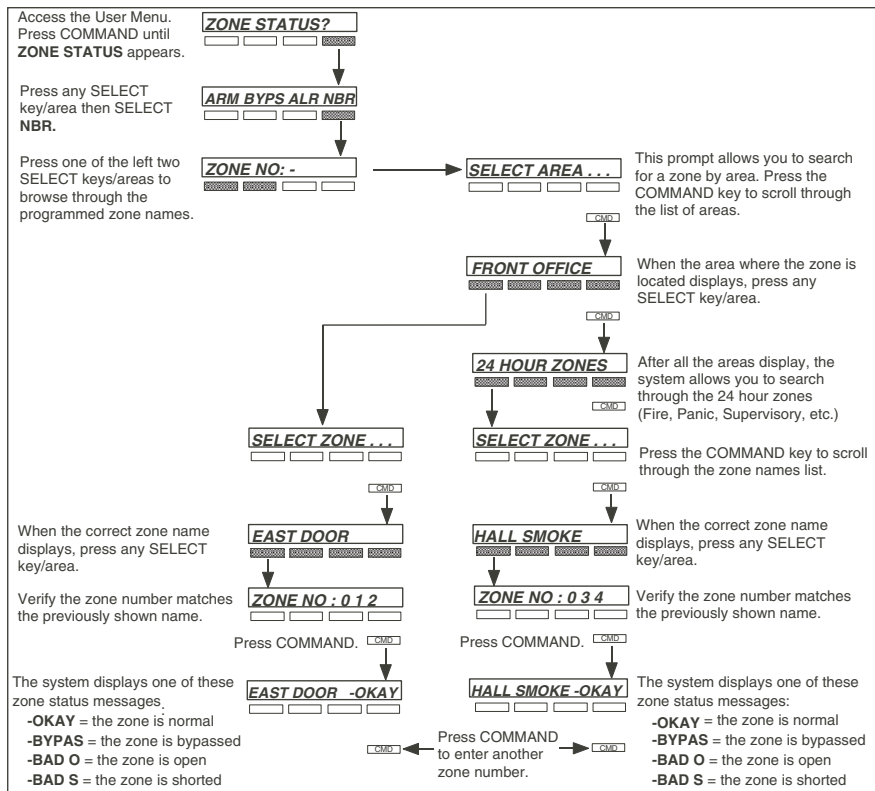

Outputs On/Off Browser

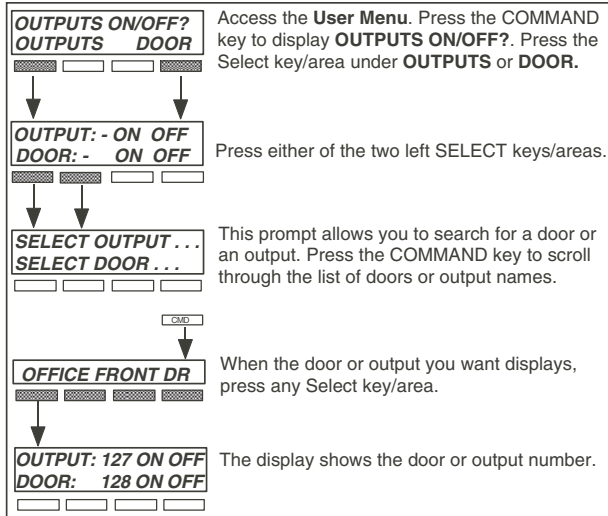

Output Groups Browser

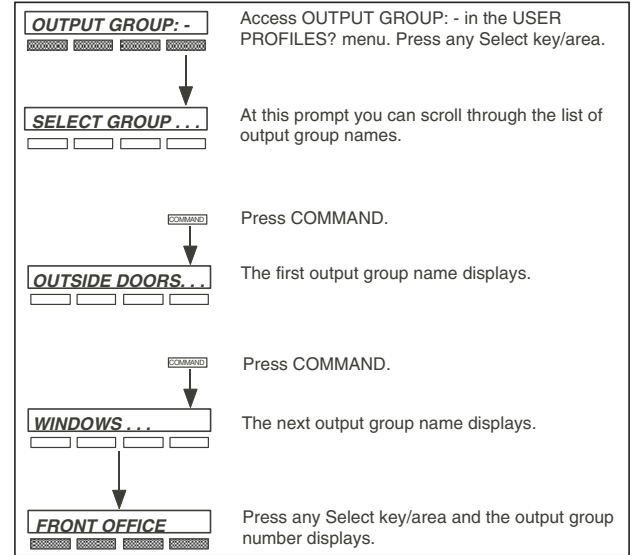

Change User Profiles Browser

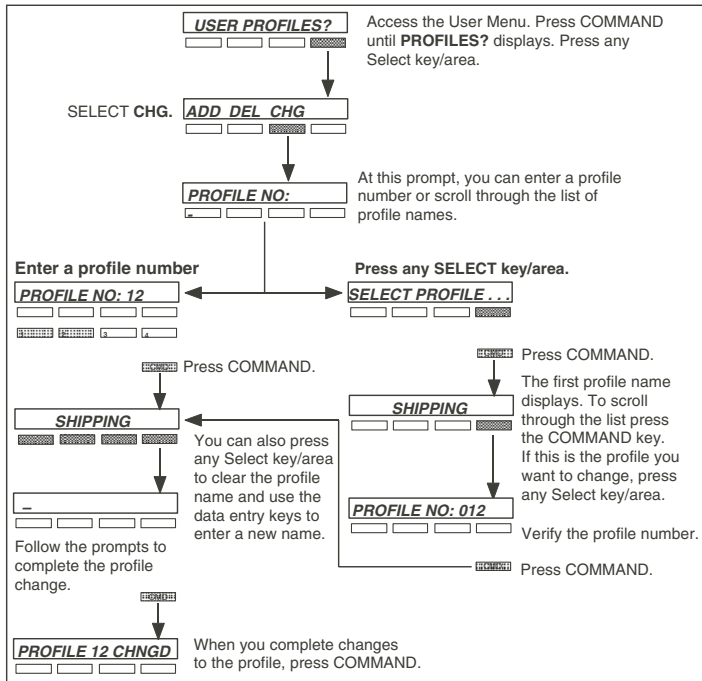

Add User Codes Browser

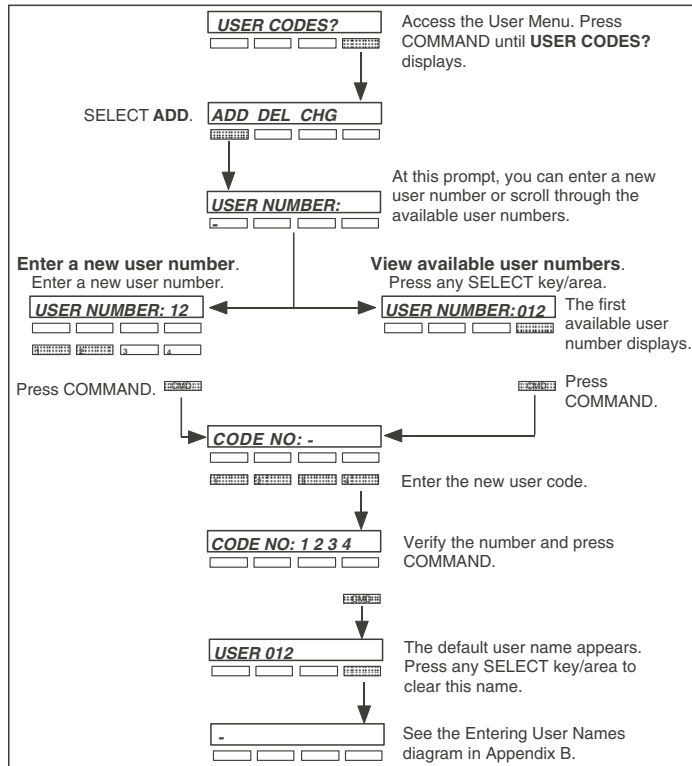

Delete User Codes Browser

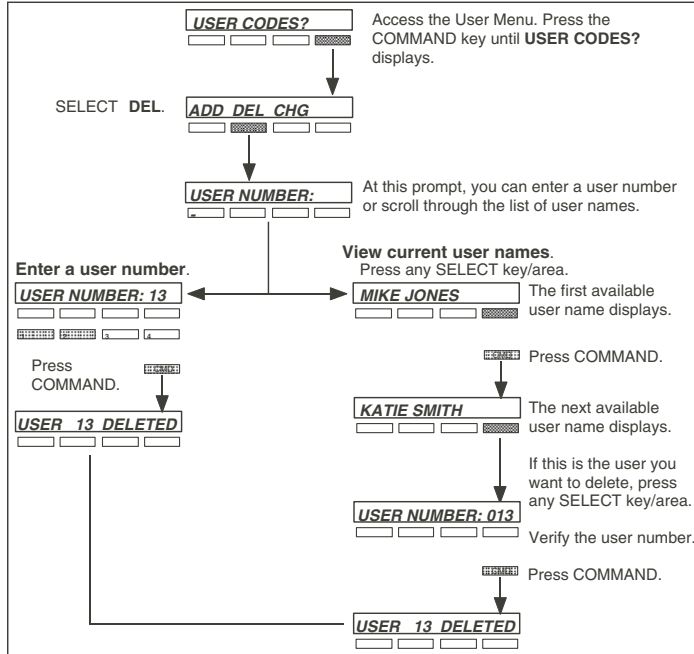

Change User Codes Browser

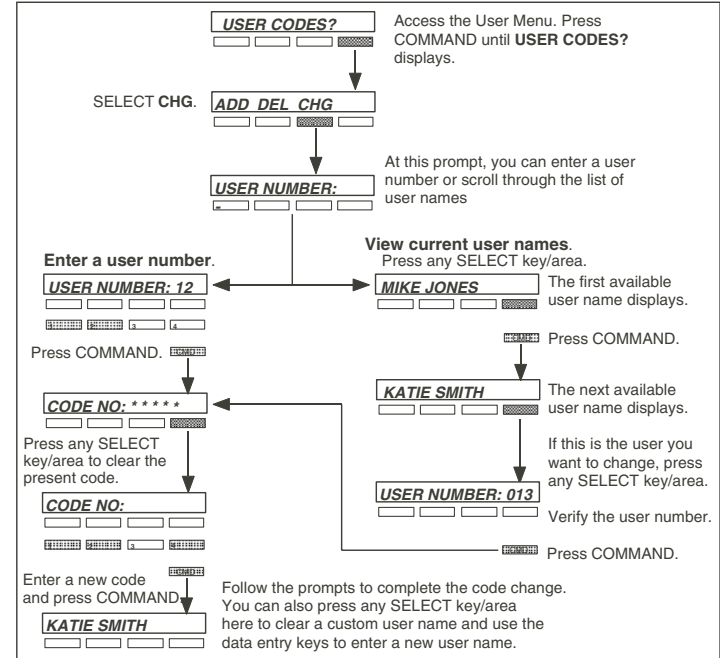

Entering User Names

1
To enter a custom name into the keypad, you use the three rows of number keys.

2
Under each number key are three letters. To enter a custom name, press the number key above the letter you want to enter.

3
With the number displayed, press the SELECT key/area that matches the letter position. See example.

4
Once the letter you want displays, press the number key above the next letter you want to enter.

You can enter up to 16 characters for each name into the keypad.

The nine and zero keys . .

Pressing the 9 key provides you with Y, Z, and a space to use between names. For example: BOB SMITH.

Pressing the 0 (zero) key provides you with a - (dash), . (period), * (asterisk), and a # (pound sign).

Appendix C

Common Keypad Displays

Listed below are several keypad messages you may see on the display. Follow the instructions in the Possible Solutions column to correct the problem. In many cases, you need to call a service person to correct the problem. Displays that are not discussed here mean that your service representative should be called.

Message	Meaning	Possible Solutions
INVALID AREA	The user has attempted a door access to an area they are not assigned.	Change the user access areas if access to the area is needed. If access is not needed, the user cannot enter the area.
INVALID CODE	The user code you entered is not recognized by the system.	Check the user code and try again.
INVALID PROFILE	A user has attempted a function that is outside of the assigned profile.	Check the user profile settings.
INVALID TIME	A user code assigned to a specific schedule was entered outside of the valid schedule.	See Schedules and User Codes. Check the system clock.
ENTER 2ND CODE	The area you are attempting to disarm or access is a Two Man Area.	A second and different user code must be entered.
CLOSING TIME!	The scheduled has expired and in a short time the area will automatically arm.	Users still on the premise should arm the system or extend the schedule to a later time.
LATE TO CLOSE	The system was not armed at its scheduled closing time.	Users still on the premise should arm the system or extend the schedule to a later time.
FAILED TO EXIT	A user assigned the anti-passback option has attempted to re-enter an area from which they did not exit properly.	The user must exit the area through the proper door. If not possible, your system administrator should select the Forgive option in the User Codes menu.

Index

A

- Add User Codes 16
 - Browser 28
- ALARM 6
 - Cancelled 6
 - Not Sent 6
- ALARM LED 3
- Alarm Silence 9
- Ambush Codes 22
- Anti-Pass Back 6, 15
- Area Display 4
- AREA LATE! 18
- Armed Areas 6
- Asterisks 4

B

- Back Arrow key 3
- Browser
 - Add User Codes 28
 - Change User Codes 29
 - Change User Profiles 28
 - Delete User Codes 29
 - Outputs On/Off 27
 - Output Groups 27
 - Zone Status 26

C

- Change User Codes 17
 - Browser 29
- Change User Profiles 15
 - Browser 28
- CLOSING TIME! 18
- COMMAND key 3

D

- Data Entry keys 3
- Date and Time 21
- Delete User Codes 17
 - Browser 29
- Displays
 - ALARM 6
 - Alarm Cancelled 6
 - Alarm Not Sent 6
 - Area 4
 - Armed Area 6
 - Device 4
 - Enter Code 6
 - Invalid Area 6
 - Invalid Code 6
 - Invalid Profile 6
 - Invalid Time 6
 - Multi-lingual Option 4
 - Service Required 7
 - Silenced 6

Supervisory 6

System Busy 7

System Trouble 7

Trouble 6

Try Again 6

Display Events 22, 23

User Code Change Event Displays 24

Zone Event Displays 24

Door Lock/Unlock 9

DRILL Key 5

E

- Emergency Evacuation Plans 1
- Entering User Names 30

F

- Failed to Exit 7
- Favorites 18
- Fire Command Center 2, 3
 - ALARM 6
 - Back Arrow Key 3
 - COMMAND key 3
 - Data Entry Keys 3
 - Function keys 5
 - Select Keys 3
 - Status LEDs 3
- Fire Command Center Displays 6
- Fire Command Center Tones

- Exit 7
- Fire Alarm 7
- Key Press 7
- Prewarn 7
- Trouble 7
- Fire Drill 22
- Function Keys 5
 - DRILL Key 5
 - RESET Key 5
 - SILENCE Key 5
 - TEST Key 5

I

- Invalid Area 6
- Invalid Profile 6
- Invalid Time 6

K

- Keypad Display Options 4
 - Asterisks 4
 - Current Programming 4
 - Multi-lingual 4

L

- LEDs 3
 - Alarm LED 3
 - Power LED 3
 - Trouble LED 3
- Lockdown 9

M

- Multi-lingual Display 4

O

- Outputs On/Off
 - Browser 27
- Output Groups
 - Browser 27

P

- Panic Zone Test 13
- Profiles 14
 - Changing 15
- Programming
 - Current Keypad Display Options 4

R

- Re-Arm Delay 15
- Remote Annunciator Keypad 6
- Remote Fire Command Center 6

S

- Schedules 18, 19, 21
 - Holiday (HOL) 18, 21
 - Setting Holiday ABC Schedules 20
 - Setting Output and Door Schedules 20
 - Times 18
- Select keys 3
- Service Request 22

- Service Required 7
- Silence Alarm b
- Silenced 6
- Status LEDs 3
- System Busy 7
- System Status 12
- System Test 13
- System Trouble 7

T

- TEMP CODE 15
- Tones 7
 - Exit tone 7
 - Fire Alarm tone 7
 - Key press tone 7
 - Prewarn tone 7
 - Trouble tone 7
- TROUBLE LED 3

U

- User Codes 16
 - Adding 16
 - Changing 17
 - Deleting 17
 - Names 16
- User Menu 2, 8
- User Menu Options
 - Door Access 10
- User Options 5
- User Profiles 14

Anti-Pass Back 15
Re-Arm Delay 15
Shift Schedules 15
Temporary Code 15

Z

Zone Status
 Browser 26
Z-Wave 11, 18

