

XR100FC/XR500FC

USER GUIDE

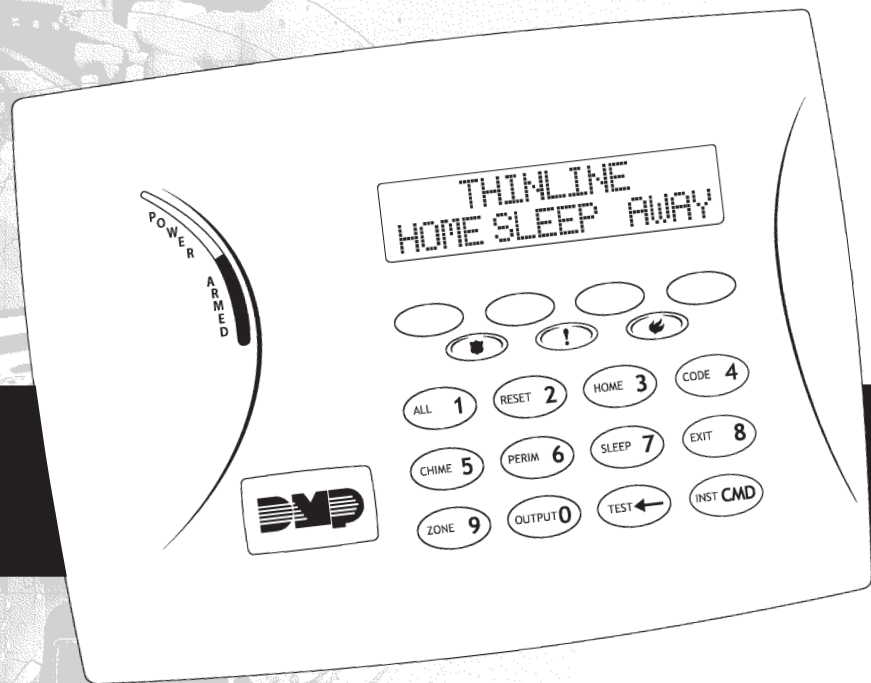

Silencing an Alarm

While the fire alarm horns, strobes, or sirens are sounding use one of the following methods to silence the alarm.

1. Turn the keyswitch to enable the four function keys. Then press the SILENCE key.

OR

2. Enter your user code. Then press COMMAND.

Note: You may silence an alarm using both of the above methods on the Remote Fire Command Center as well.

Copyright© 2012 Digital Monitoring Products, Inc.

Information furnished by DMP is believed to be accurate and reliable.

This information is subject to change without notice.

XR100FC/XR500FC User's Guide

Table of Contents

<i>Section</i>	<i>Page</i>	<i>Section</i>	<i>Page</i>
Silencing an Alarm	b	Outputs On Off	9
XR100FC/XR500FC User's Guide	i	Zone Status	10
Table of Contents	i	System Status.....	11
Emergency Evacuation Plans	iii	System Test	11
Draw a floorplan of your home or business	iii	User Profiles	12
Develop escape routes.....	iii	User Profiles Reference.....	13
Decide where to meet	iii	User Codes	14
Practice your escape plans	iii	Setting the Date and Time	16
Early detection	iii	Ambush Codes	17
Introduction	1	Display Events	17
About Your Fire Alarm Control Panel	1	Service Request	17
Fire Command Center	1	Fire Drill	17
User Menu	1	Appendix A	18
The Fire Command Center	2	About the Display Events Section.....	18
Using the Keypad	3	Zone Event Displays	19
Four Function Keys.....	4	User Code Change Event Displays	19
Special Fire Command Center Displays.....	5	Supervisory Event Displays	20
Special Fire Command Center Tones	6		
Fire Command Center User Menu	7		
Alarm Silence.....	8		
Sensor Reset.....	8		

Appendix B	20
Zone Status Browser	20
Outputs On/Off Browser	22
Output Groups Browser	22
Change User Profiles Browser.....	23
Add User Codes Browser.....	23
Delete User Codes Browser	24
Change User Codes Browser	24
Entering User Names.....	25
Appendix C	26
Common Keypad Displays	26

Emergency Evacuation Plans

The National Fire Protection Association recommends that you establish an emergency evacuation plan to safeguard lives in the event of a fire or other emergency.

Draw a floorplan of your home or business

On a sheet of paper, draw the walls, windows, doors, and stairs. Also draw any obstacles, such as large furniture or appliances, a person may encounter while exiting the building.

Develop escape routes

Determine at least two routes the occupants in each room can take to safely escape. One route can be the most obvious such as the door. Another can be through a window that can be easily opened. If the window is high off the ground, an escape ladder should be provided. Draw arrows on the floorplan to show escape routes from each room.

Decide where to meet

Prearrange a meeting place outside and away from where emergency personnel are likely to be working. A neighbor's house or across the street in the front of the house are good locations. Always perform a head count to make sure all occupants safely exited. NEVER ENTER A BURNING BUILDING. If the head count shows one or more persons missing, give this information immediately to the authorities. Never enter a building to look for someone.

Practice your escape plans

Devising an escape plan is only the beginning, before the plan can be effective everyone should practice the escape routes from each room.

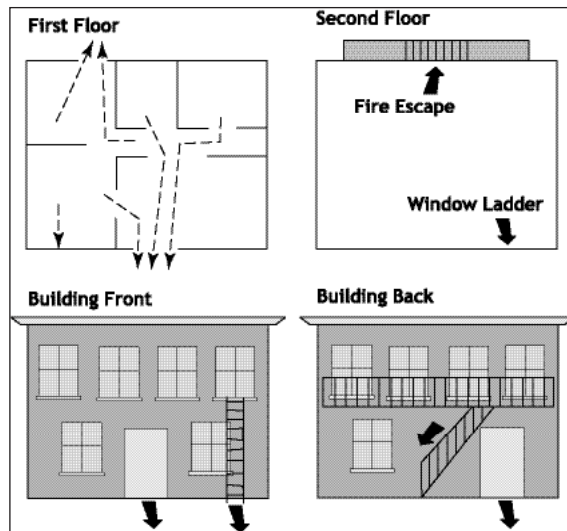

Early detection

The best way to survive a fire or other emergency is to get out early. The installation of a fire alarm system, with smoke and carbon monoxide detectors in each room, can greatly decrease your risk of loss or injury.

This page intentionally left blank

Introduction

About Your Fire Alarm Control Panel

The Fire Alarm Control Panel is designed with your safety and comfort in mind. It uses the latest in computer based technology to create the most advanced and user-friendly fire, security, and access control system available.

The Fire Alarm Control Panel combines ease-of-use with a simple-to-understand Fire Command Center display to offer the full range of features requested by today's fire system owners.

You can turn portions of your protection on or off at any time by pressing a few keys. You can add, delete, and change personal user codes at any time or check the status of protection devices in the system. An added feature of the Fire Alarm Control Panel is the membrane keyboard with four additional function keys you may use to easily perform a variety of functions.

Fire Command Center

The XR100FC/XR500FC comes with a built-in LCD display with a 20-key membrane keyboard called the Fire Command Center. The keyboard is mounted behind an opening in the red enclosure door. Use the keyboard to perform a variety of functions as listed in this User's Guide.

A Remote Fire Command Center is also available to use with the XR100FC/XR500FC Addressable Fire Alarm Control Panel. The remote keyboard can be placed anywhere throughout the premises.

Both keyboards have four additional function keys, to be used for alarm silencing, resetting smoke detectors, system testing, and performing fire drills. Both keyboards require the user to turn a keyswitch to enable the four function keys.

User Menu

The keyboards also provide access to the User Menu, which contains all of the functions necessary to fully operate your system.

The Fire Command Center

Your system comes equipped with a built-in, easy-to-use Fire Command Center that allows you to properly operate the system. The Command Center is also available in a remote version. The keyswitch to the left of the keyboard must be turned to the “enable” position before you can use the four functions keys. It is not necessary to use the keyswitch when using a user code to perform operations. The illustration and descriptions below highlight some features of the Fire Command Center:

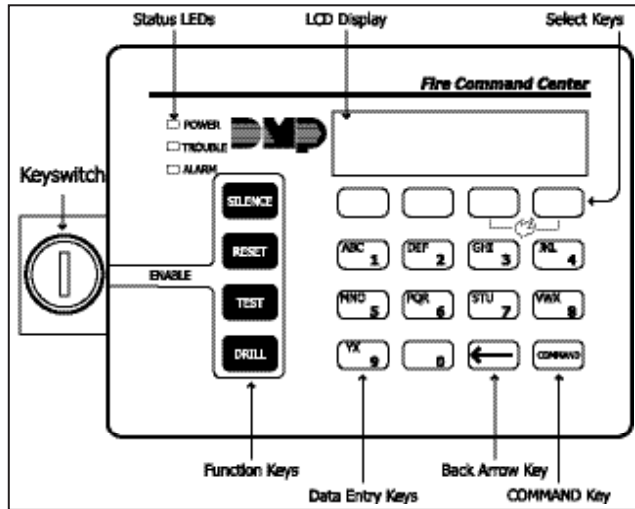

The Select keys

There are four keys under the display called the Select keys. They allow you to choose what to do by pressing the Select key under choices being shown in the display.

Data Entry keys

These keys allow you to enter your user code and other information into the system.

The Back Arrow key

Use the Back Arrow key to go back through displays while operating your system. Press the Back Arrow key to back up through the list of User Menu functions or to make a correction by erasing the last character you entered.

The COMMAND key

The COMMAND key allows you to advance through the displays or User Menu or complete a data entry function.

Status LEDs

The Fire Command Center incorporates three LEDs to indicate the system status. The three indicator lights are described below.

POWER LED

This LED remains ON steady when both AC and battery input are good. The LED turns OFF when AC input is low. The LED flashes at half-second intervals when battery input is low.

TROUBLE LED

This LED turns ON when any trouble displays in the status list, such as AC, battery, phone line, transmit, ground fault, NAC, or any zone trouble. This light is OFF when no trouble displays in the status list.

ALARM LED

The ALARM LED is ON when any alarm currently displays in the status list. This LED is OFF when no alarm currently displays in the status list.

Using the Keypad

Multi-lingual Display Option

Your system may be programmed to display the User Menu and Status Display text in multiple languages. When the COMMAND key is pressed, the option to choose the language displays. The language chosen continues to display at this keypad until another language is chosen.

Keypad Displays Current Programming

Most User Menu options displayed at the keypad show the currently selected option in the panel memory. These options are either shown as a number, a blank, or a **NO** or **YES**. To change a number press any top row Select key. The current option is replaced with a dash. Press the number(s) on the keypad you want to enter as the new number for that option.

It is not necessary to enter numbers with leading zeros. The panel automatically right justifies when you press the COMMAND key.

To change an option that requires a **NO** or **YES** response, press the top row Select key under the response not selected.

For example, if the current option is **YES** and you want to change it to **NO**, press the third top row Select key. The display changes to **NO**. Press the COMMAND key to go to the next option.

Multiple Displays

For many User Menu options on burglary keypads of combination burglary and fire systems, such as **Access Areas**, there are several displays containing lists. For example, in **Access Areas**, areas 1 through 32 display on four separate displays. First, areas 1 through 8 display. Press the COMMAND key to display areas 9 through 16. Press the COMMAND key again to display areas 17 through 25. Press the COMMAND key one more time to display areas 26 through 32.

Note: Only areas pre-programmed at installation can display.

Asterisks in Burglary Area Armed Displays

Asterisks display next to a programming option that is already selected. As shown in the example, options chosen to display the current programming selection have an asterisk next to the number. Those that are not selected simply display the number. In the example, Burglary Areas 3, 8, 9, 15, 19, 23, 25, and 31 are not selected. In both examples the numbers with asterisks are selected.

*1	*2	3	*4	*17	*18	19	*20
*5	*6	*7	8	*21	*22	23	*24
9	*10	*11	*12	25	*26	*27	*28
*13	*14	15	*16	*29	*30	31	*32

To select or deselect a number, simply enter the number using the digit keys on the keypad. This same scheme is used when viewing the panel armed status and other programming and operational functions. Remember to press the COMMAND key to display the rest of the device or area numbers.

User Options

The User Options allow you to make adjustments to your keypad to best fit your environment and needs.

To access the User Options portion of the keypad, press and hold the Back Arrow and COMMAND keys for two seconds. The keypad display changes to SET BRIGHTNESS. Press the COMMAND key to display the next option or the Back Arrow key to exit.

Backlighting Brightness

Sets the keypad LCD, and AC LED backlighting brightness level. At the SET BRIGHTNESS display, use the left Select key to lower the keypad brightness. Use the right Select key to increase the brightness.

Note: If the brightness level is lowered, it temporarily reverts back to maximum intensity whenever a key is pressed.

Internal Speaker Tone

Sets the keypad internal speaker tone. At the SET TONE display, use the top left Select key to make the tone lower. Use the right Select key to make the tone higher.

Volume level

Sets the keypad internal speaker volume level for key presses and prewarn conditions. During alarm, trouble, and prewarn conditions, the volume is always at maximum level. At SET VOLUME LEVEL, use the left Select key to lower the keypad volume. Use the right Select key to raise the volume.

Model Number

The keypad model number, firmware version, and date display, but cannot be changed.

Four Function Keys

The Fire Command Center is designed with four additional keys on the left side of the keypad. After turning the keyswitch, you can quickly perform vital functions using these four keys.

SILENCE Key

Pressing the SILENCE key silences the alarm bells.

RESET Key

Pressing the RESET key performs a sensor reset and silence the alarm bells.

TEST Key

Pressing the TEST key performs a system test.

DRILL Key

Pressing the DRILL key displays a prompt "SURE? YES NO". Press YES to begin the fire drill. Press NO to return to the status list.

Special Fire Command Center Displays

As you use your system, you occasionally see a display that asks you to enter a code or that describes a condition on the system. Below are some examples of the displays:

ALARM

A 24-hour zone (for example fire or panic) or an armed burglary zone has been tripped. Your system may sound bells or sirens.

ALARM NOT SENT (Burglary Keypad)

The alarm signal was not sent to the central station because a user code was entered to disarm the system before the alarm signal was sent to the central station.

ALARM CANCELLED (Burglary Keypad)

An Alarm Cancel signal was sent to the central station because a user code was entered after an alarm was sent to the central station.

SILENCED

An Alarm Silence has been performed to turn off the notification appliances. Zone names are displayed on the bottom line of the keypad display.

SUPVSRY (SUPERVISORY)

A Supervisory type zone alarm has occurred. The zone name is displayed on the bottom line of the keypad display.

TROUBLE

There is a problem with a protection device or system component. This display is accompanied by a description of the problem.

ENTER CODE

The system requires you to enter your user code. User codes can be required for turning your system on (arming), turning your system off (disarming), and many other functions.

As you enter your user code, the keypad display shows an asterisk (*) in place of each digit pressed. This keeps others from seeing your user code on the display as it is entered.

TRY AGAIN or INVALID CODE

The user code you have entered is not recognized by the system. Check the user code and try again.

INVALID PROFILE

All user codes have a profile that allow the user to only access certain functions. When users attempt functions outside their authority, the INVALID PROFILE message displays.

INVALID AREA

A user has attempted a door access for an area they are not assigned.

INVALID TIME

A user code assigned to a specific schedule is entered outside of the valid schedule. See Schedules and User Codes.

ARMED AREA

A user has attempted a door access to an armed area to which they do not have arming and disarming authority.

FAILED TO EXIT (ANTI-PASS BACK) (Burglary Keypad)

Anti-passback requires users to properly exit (egress) an area they have previously accessed. If they fail to exit through the proper card reader location they are not granted access on their next attempt. A Failed to Exit message appears when a user assigned the anti-passback option attempts to re-enter an area which they did not exit properly. The user must exit the area through the proper door. If not possible, your system administrator should select the Forgive option in the User Codes menu option.

SYSTEM TROUBLE or SERVICE REQUIRED

There is a problem with one or more of the components in your system. Contact our service department as soon as possible.

SYSTEM BUSY

The Security Command system is performing another task of a higher priority. This usually only takes a few moments.

Special Fire Command Center Tones

Your keypad also contains a small speaker that alerts you about events as they occur on your system. For an alarm, as soon as the first digit key is pressed to enter a user code, the tone stops. If no other keys are pressed for five seconds or an invalid code is entered, the tone turns on again.

Fire Alarm tone: An intermittent sweeping siren that sounds until the fire alarm is silenced.

Key press tone: A short beep each time you press a key on the keypad and it is acknowledged by the system.

Prewarn tone: A continuous pulsed tone that sounds when you open an entry delay door on a system that is armed (turned on) reminding you to disarm the protection. The tone silences as soon as the first user code digit key is pressed.

Exit tone: A continuous pulsing tone that sounds during the exit countdown just after arming to remind you to exit the premise. At ten seconds prior to the end of the countdown, the rate of pulsing increases.

Trouble tone: A steady tone indicating a trouble condition on your system. Press a Select key to silence.

What to do when the trouble tone sounds

You can silence the trouble tone by pressing any key. This only silences the keypad and does not correct the condition that originally caused the trouble.

User Menu

Fire Command Center User Menu

Many of your system features are included in a User Menu you can access from the Fire Command Center or the Remote Fire Command Center. The menu requires you to enter your user code and then only shows those functions to which you have access.

Some features displayed on the User Menu are not necessary for the XR100FC/XR500FC Addressable Fire Alarm Control Panel. Please disregard these prompts and displays. Press the COMMAND key to skip any displays and prompts not discussed in this User Guide.

Accessing the User Menu

1. Press the COMMAND key, if the multi-language option is enabled, the available languages display. Press the top row Select key under the language to use for text display.
2. Press the COMMAND key until MENU? NO YES displays.
3. Select YES. The keypad displays ENTER CODE: -. Enter your user code and press COMMAND. You can now scroll down through the list of system features available to you.

User Menu Options

The list below shows the User Menu options in the order they display.

Menu Option	Description
ALARM SILENCE	Silences an alarm bell or siren.
SENSOR RESET	Resets smoke or glassbreak detectors that have latched due to an alarm condition.
OUTPUTS ON/OFF	Allows you to turn on or off any of the outputs described in the System Setup section of this guide.

The following pages detail each user menu item and provide instructions on when and how to properly use them.

Alarm Silence

Silences the alarm bells or sirens during an alarm.

Alarm Silence allows you to turn off the alarm bells and sirens connected to your system during an alarm. Using Alarm Silence does NOT stop an alarm report from being sent to the central station and does not reset any alarmed devices. Use the Sensor Reset function to reset devices such as smoke detectors that latched in alarm.

Note: The keypad tone silences as soon as the first user code digit key is pressed. You can also silence an alarm by entering your user code and pressing COMMAND or by presenting your card to a reader while the Status List displays. If using a proximity card, areas assigned to your card may be disarmed and door access occurs.

Using the Alarm Silence Function

1. Access the User Menu.
2. The keypad displays ALARM SILENCE?.
3. Press any Select key to silence the bells and exit the User Menu.

Sensor Reset

Resets smoke or glassbreak detectors. Also clears Fire/Supervisory alarm and trouble displays.

Sensor Reset is used to reset smoke and glassbreak detectors after they have tripped. Once these detectors trip, they must be reset before they can detect any additional alarm conditions. When you select Sensor Reset, power to the detectors is temporarily removed by the system allowing them to reset.

Make sure all smoke is cleared from around the smoke detector areas before performing a Sensor Reset to prevent the alarm from occurring again.

Resetting the Sensors

1. Access the User Menu.
2. Press COMMAND until SENSOR RESET displays.
3. The keypad displays SENSORS OFF for five seconds followed by SENSORS ON.
4. The keypad automatically exits the User Menu.

Outputs On Off

Allows you to manually turn the system or door access relay outputs ON and OFF.

This function is used to individually turn your system relay and access door outputs ON and OFF. Your system may use these outputs to control door access, interior and exterior lighting, heating, air conditioning, or other appliances.

The names and numbers of the relays connected to your system are located in the System Setup section of this guide.

Outputs can be turned ON or OFF regardless of the output settings in Schedules.

Your system may be programmed to require that your user code profile have access to areas assigned to the keypad. INVALID AREA displays when your user code does not have access to the keypad's areas and the output does not turn on.

Under certain conditions, some outputs cannot be turned on. If you select a restricted output, the keypad displays CANNOT TURN ON.

Turning the Outputs ON and OFF

1. Access the User Menu.
2. Press COMMAND until OUTPUTS ON/OFF? displays.
3. Press any Select key to display OUTPUTS DOOR.
4. Select the type of output you want to turn ON or OFF by pressing the Select key under OUTPUTS or DOOR.
5. Enter the output number you want to turn ON or OFF. The output number displays. The range for outputs is 1-6, 500-999. The range for the door is 1-16.
6. With the output number displays, press the Select key under ON or OFF. The output then turns ON or OFF depending on your Selection, and remains in that state until you change it. The keypad displays the output or door name first 12 characters followed by either ON or OFF for four seconds to provide visual verification of the action. Press the COMMAND key to end the four second display.
7. The system automatically returns to the output or door prompt to allow you to select a new output to turn ON or OFF. Refer back to step 4.
8. Press the Back Arrow key to exit the User Menu.

Browser Feature

If you are unsure of the output number, refer to Appendix B at the back of this guide for a diagram showing you how to use the built-in Outputs ON/OFF browser.

Zone Status

Displays a list of armed, bypassed, or alarmed zones. Also allows you to check individual zone status. Zone Status can be used to give you a list of zones by category or display the current status of an individual zone number. The four categories are:

- Armed Zones - zones that are currently armed.
- Bypassed Zones - zones that are currently bypassed.
- Alarmed Zones - zones that have gone into alarm during the current or previous armed period.
- Number - enter the number of any zone to check its status.

Using the Zone Status Function

1. Access the User Menu.
2. Press COMMAND until ZONE STATUS? displays.
3. Press any Select key to display ARM BYPS ALR NBR.
 - 3a. Select ARM for a list of zones that are currently armed. You can scroll through the list by pressing the COMMAND key.
 - 3b. Select BYPS for a list of zones that are currently bypassed.
 - 3c. Select ALR for a list of zones that have gone into alarm during the current or previous armed period.
 - 3d. Press NBR and ZONE NO: - displays.

4. At the ZONE NO: - prompt, enter the zone number you want to check and press COMMAND. The zone number and name display followed by the zone status. For example, a zone status for zone 1 might be BACK DOOR - OKAY.

Below is a list of the zone status displays:

- OKAY = the zone is in a normal condition
- BYPAS = the zone is bypassed
- BAD = the zone is in a bad or faulted condition

5. After displaying the zone status, ZONE: - returns for you to enter another zone number.

Browser Feature

If you are unsure of the zone number or description, refer to Appendix B at the back of this guide for a diagram showing you how to use the built-in Zone Status browser.

System Status

Displays the internal system hardware current condition.

System Status shows the panel condition of AC power, battery power, and optional panel tamper. When System Status is selected, each monitor displays followed by OKAY or TRBL (Trouble) to indicate the current condition.

Using the System Status Function

1. Access the User Menu.
2. Press COMMAND until SYSTEM STATUS? displays.
3. Press any Select key. The display starts listing each system monitor and status.

For example: AC POWER - OKAY

Below are the System Monitor displays:

Keypad Display	What it monitors
AC POWER	AC power
BATTERY	Battery power
TAMPER	Panel box tamper

These are followed by either OKAY or TRBL (trouble).

If TRBL displays, call the service department for assistance.

4. The system then displays its firmware version (for example, VER_201_3/08/04), the panel model (MODEL XR500N), and then exits the User Menu.

System Test

System Test is used to test the battery, alarm bell or siren, and communication to a central station. The System Test function begins automatically as soon as you select it.

Using the System Test Function

1. Access the User Menu.
2. Press COMMAND until SYSTEM TEST? displays.
3. The keypad displays SYSTEM PANICS. Press the Select key below SYSTEM.
4. The System Test begins automatically and the keypad displays the following messages in this order:
 - 1) **BELL SOUNDING** during a two second bell test
 - 2) **KEYPAD SOUNDING** all keypads assigned to the same area sound their alarm tone for two (2) seconds during the keypad sounder test
 - 3) **BATTERY - OKAY** or **BATTERY - TRBL** to indicate the battery condition
 - 4)* **TRANSMIT TEST** and **ATTEMPT NO: 1** during the transmit test
 - 5) **TRANSMIT OKAY** or **TRANSMIT FAILED** to show the results of the transmit test
 - 6) **TEST END** to indicate the System Test is complete.
 - 7) You can press the Back Arrow key to end the transmit test.

* The transmit test does not occur on local systems.

Using the Panic Zone Test

1. Access the User Menu.
2. Press COMMAND until SYSTEM TEST? displays.
3. Press any Select key. The keypad displays SYSTEM PANICS.
4. Press the Select key below PANICS.
5. The Panic Zone Test begins automatically and the keypad displays TRIPS: END.

During the Panic Zone Test, trip each panic zone (or button) on the system by pressing and holding the panic for 1 to 2 seconds.

Note: You do NOT have to hold the panic for 2 seconds in normal mode. You are only required to hold the panic during the Panic Zone Test because the zone takes additional time to report when the system is in test mode.

Each time you trip a panic zone, the display number increments and the keypad buzzer sounds for two seconds.

The number of panic zones tripped constantly displays until the test ends or no panic zone activity has occurred for 20 minutes.

6. Press the Select key below END to stop the Panic Zone Test.
7. PANIC TEST OKAY displays when the Panic Zone Test is completed and all zones tested OK.
8. When the Panic Zone Test ends and a zone failed (did not trip) during the test, the keypad displays the zone name and number and the buzzer sounds for one second. Press the COMMAND key to display the next failed zone.

Note: During the Panic Zone Test, any zones that fail are not sent to the receiver unless pre-programmed at installation to be sent.

User Profiles

Change User Profiles, that define the authority of each user code in the system. Several characteristics define the authority of each User Profile within the system.

Profile Number - Each profile may be assigned a unique number from 1 to 99.

Profile Name - Each profile may be assigned a 16-character name. The Profile Number is the default name.

Arm or Disarm Areas - Each profile may be assigned specific areas of the system for arming and disarming. When profiles 1 to 98 are created, NO areas are assigned by default. The default for profile 99 is ALL areas assigned. Profile 99 is predefined in the system by the factory.

Access Areas - Each profile may be assigned door access area assignments. Default for profile 1 to 98 is NO areas assigned. Default for profile 99 is ALL areas assigned. Profile 99 is predefined at the factory.

Output Group Assignment - Each profile may be assigned an output group number from 1 to 10. Default for profile 1 to 98 is NO output group assigned. Default for profile 99 is output group 10. Your system may be programmed to turn on an output group at certain keypads when door access occurs.

User Menu Assignments - Each user profile may have any of the menus assigned to it as shown in the User Profile Record below. The User Profile Record lists the user menu profile assignments and the system functions users are allowed to access based on the profile numbers assigned to their codes.

Always make sure that at least one administrator in your system has a profile with **all** authorities and **all** areas.

User Profiles Reference

Menu Display			Privilege
ARM	NO	YES	Arm
DIS	NO	YES	Disarm
ALM SLNC	NO	YES	Alarm Silence
SNSR RST	NO	YES	Sensor Reset
DOOR ACS	NO	YES	Door Access
ARM AREA	NO	YES	Armed Areas
OUTPUTS	NO	YES	Outputs ON/OFF
ZN STATS	NO	YES	Zone Status
BYPAS ZN	NO	YES	Bypass Zones
ZONE MON	NO	YES	Zone Monitor
SYS STAT	NO	YES	System Status
SYS TEST	NO	YES	System Test
PROFILES	NO	YES	User Profiles
USR CODE	NO	YES	User Codes
SCHEDULS	NO	YES	Schedules
TIME	NO	YES	Time
DIS EVNT	NO	YES	Display Events
SERV REQ	NO	YES	Service Request
FIRE DRILL	NO	YES	Fire Drill
EXTEND	NO	YES	Extend Schedules
TEMP CODE	NO	YES	Temporary User Code
ANTI PASS	NO	YES	Anti-Passback
ALOW: 1234		ANY	Allow: Shift/Time Access
RE ARM DLY	0 – 250		Re-Arm Delay
SEC LANGUAGE	NO	YES	Preferred Language

Changing User Profiles

1. Access the User Menu.
2. Press COMMAND until USER PROFILES? displays.
3. Press any Select key. The keypad displays ADD DEL CHG.
4. Press the far right Select key, under CHG.
5. At the PROFILE NO: - option, enter a profile number and press COMMAND. The display changes to PROFILE NAME.
6. Press any Select key to display -. Enter a profile name of up to 16 characters. The default Profile Name uses the Profile Number. Enter the name and press COMMAND.
7. At the Arm/Dis AREAS: option, enter the area numbers (1-32) for arming and disarming assigned to this profile.
8. The keypad displays ACCESS Areas: . Enter the area numbers (1-32) assignment to allow door access for this profile. Press the COMMAND key.
9. The keypad displays OUTPUT GROUP: -. Enter the number (1 through 20) for the Output Group assigned to this profile. Press the COMMAND key.
10. The keypad displays each of the menus as shown in the Profile Table. You then enable or disable the menu function for this profile number. Select YES or NO and press the COMMAND key to advance to the next menu selection.
11. When you complete Selecting all User Profile menu assignments, the keypad displays the PROFILE CHNGD message for 4 seconds, indicating the profile is changed.

TEMP CODE

When you select YES for this menu option, and this profile is assigned to a user code (see next section), the keypad displays TEMP EXPIRE DATE:.. Enter the ending date for the profile to expire. Default is seven days from today. The system deletes Temp users at 12:00 AM on the last date.

ANTI PASS NO

Anti-passback requires that you properly exit (egress) an area previously accessed. When you fail to exit through the proper location you cannot access it until you properly exit. Default is No. See page 6 for more information.

ALOW: 1 2 3 4 ANY

This menu option defines the time schedules that the User Code operates for door access and disarming. Selecting 1, 2, 3, and/or 4 indicates operation during the S1-S4 shift schedules. Selecting ANY (fourth Select key) from the menu indicates the code operates any time, regardless of schedules. You may select all shift schedules for one user. Menu access is not affected by this option. An UNAUTHORIZED ENTRY message is sent to the central station if disarming occurs outside the open/close schedule.

RE ARM DELAY

RE ARM DELAY allows the entry of 0 to 250 minutes to be used to delay automatic rearming when the user disarms an area outside of schedule. If zero is selected, the rearming occurs based on permanent programming in the panel.

RE ARM DELAY is also used to delay a late to close message to the central station when the panel does not use automatic arming.

If the user has Extend Schedule authority, 2HR 4HR 6HR 8HR displays at disarming. If the user does not make a choice, the RE ARM DELAY is used to extend the schedule.

Application example: An exit door near the trash is scheduled to be armed at all times. When the custodian needs to remove trash, program 10 minutes for the activity. Or, an overhead door only requires access when a delivery is made. Program up to 250 minutes to allow the loading dock supervisor to load or unload a semi-truck.

Browser Feature

Refer to Appendix B in this guide for a diagram showing you how to use the Output Group browser and the Profile browsers.

User Codes

This option allows you to add, delete, or change a user code. You may also assign specific User Profiles to individual users.

3848	=	User Number
34812	=	User Code
John Smith	=	User Name
7	=	Profile

User Number - Every user is numbered 1 through 9999. This number identifies the user to the system and is transmitted to the central station when the user arms or disarms areas.

User Code - Each user also has a 3 to 6 digit code, to enter into the LCD keypad when arming or disarming the system.

Note: A User Code cannot begin with zero and 3-digit codes cannot begin with 98.

For UL installations, avoid using repetitive (111) or sequential (123) codes.

User Names - Each code may also be programmed with the user name. You may enter up to 16 characters for the name.

User Profile - The user is also assigned a Profile (1 to 99) by the person administrating the system. The profile number determines the areas and functions the user can access.

Note: Your system must have at least one user with user code authority in order to be able to add or delete user codes. Be careful not to delete all users with user code authority from your system.

Adding User Codes

1. Access the User Menu.
2. Press COMMAND until USER CODES? displays.
3. Press any Select key. The keypad displays
ADD DEL CHG BAT.
4. Press the Select key under ADD or BAT (Batch) to add a new user code.
5. At the USER NUMBER: - prompt, enter a user number and press COMMAND. The display changes to USER CODE: - .
Note: Do NOT program a code for user number 1 unless you intend to use the Ambush function, see Ambush on page 17.
6. Enter a user code of 3 to 6 digits and press COMMAND. The user enters this number to arm, disarm, etc. After entering the code the keypad displays USER NUMBER ### as the user name.
7. A 16-character name may be entered to identify the user. Press any top row key to clear the current name. You may then enter the new name. After entering the name press COMMAND. See Entering Names in Appendix B.
8. The display changes to PROFILE NO: -. Select the profile number to assign a set of authorized functions to the user code as outlined in the Profile Table on the previous page.
9. At the PROFILE NO: - display, enter a profile number from 1 to 99, and press COMMAND. The displays shows USER # ADDED.

If BAT (Batch) was chosen in step 4 instead of ADD, the next available user number is automatically selected and only steps 6 and 7 repeat. The User Profile assignment is automatically selected for the next user based on the previous user entered. This batch entry method speeds up user entry in large systems.

Deleting User Codes

To delete a user code, you must have a user code with a profile that has user code authority.

1. Access the User Menu.
2. Press COMMAND until USER CODES? displays.
3. Press any Select key. The keypad displays
ADD DEL CHG BAT.
4. Press the second Select key, under DEL, to delete a user code from the system. To delete a user code, you must have a user code with a profile that has user code authority.
Note: Be careful not to delete all users with user code authority from your system. Also, the user code used to enter the user menu to delete codes cannot be deleted. In other words, you can not delete yourself.
5. At the USER NUMBER: - prompt, enter the user number you want to delete and press COMMAND. The display changes to USER # DELETED.
6. The display then changes back to USER NUMBER: - allowing you to delete another user. Press the Back Arrow key twice to exit the User Menu.

Changing User Codes

1. Access the User Menu.
2. Press the COMMAND key until USER CODES? displays.
3. Press any Select key. The keypad displays
ADD DEL CHG BAT.
4. Press the third Select key, under CHG, to change a user code.
5. At the USER NUMBER: - prompt, enter the user number to change and press COMMAND.
6. The display changes to CODE NO: *****. Press a Select key and enter the new user code. Press COMMAND.
Note: Changing a user code does not change the user number.
7. The display then shows the current user name. Press any top row key to clear. See Entering Names in Appendix B to enter a new name.
8. The display changes to PROFILE NO: -. Select the profile number to assign a set of authorized functions to the user code as outlined in the Profile Table on page 11.
9. After entering the profile number, the keypad displays
USER # CHANGED for 5 seconds followed by
USER NUMBER: -. This display allows you to change another user code. Press the Back Arrow key twice to exit the User Menu.

Browser Feature

Refer to Appendix B for diagrams showing you how to use the User Codes Add, Delete, and Change browsers.

Setting the Date and Time

Allows you to change the current date and time displayed on the LCD keypad and used by the system.

Setting the System Date and Time

1. Access the User Menu.
2. Press COMMAND until TIME? displays. Press any Select key.
3. The keypad displays the current day and time. Press the COMMAND key. The keypad displays the current date. Press the COMMAND key to make any changes.
4. The keypad displays TIME DAY DATE.
5. Press the Select key under TIME to change the time. The keypad displays - : AM PM. Enter the current time and select AM or PM. The display changes back to TIME DAY DATE.
6. Press the Select key under DAY to change the day of week. The keypad displays SUN MON TUE WED. Press the COMMAND key to display THU FRI SAT. Press the Select key under the correct day. Use the Back Arrow key to toggle between the different day of the week displays.
7. Press the Select key under DATE to change the date. The keypad displays
MONTH:- Enter up to 2 digits for the month.
Press COMMAND.
DAY:- Enter up to 2 digits for the day.
Press COMMAND.
YEAR:- Enter up to 2 digits for the year.
Press COMMAND.

The display returns to the TIME DAY DATE display.
Press the Back Arrow key to exit the User Menu.

Ambush Codes

Your system may be programmed to allow user number 1 to be used as an Ambush code. This Ambush code functions identically to a standard code with the exception that it sends a silent alarm to the central station. This silent alarm alerts the operator to a duress situation at the premises and prompts immediate notification of authorities.

Refer to the System Setup section of this guide to see if your system is programmed for Ambush. If so, do NOT program a code for user number 1 unless you intend to use the Ambush function.

Display Events

Allows you to review up to 12,000 past door access and system events. There are six event types:

Zone Activity - Zone alarms, troubles, and restorals.

User Code - Adding, deleting, and changing user codes.

Supervisory - Problems with system hardware components.

System Monitor- Problems with AC Power, Battery, phone line or tamper problems.

The system memory holds a maximum of 12,000 past events for 45 days. Any event older than 45 days automatically clears from the system memory. Also, once the full 12,000 events are stored, any new event causes the oldest event to be cleared. See Appendix A for Display Events.

Service Request

Your user code profile may be programmed for Service Request. This User Menu feature allows you to simply press any top row Select key when SERVICE REQUEST? displays and have the system automatically send a “Request for Service” message to the central station. The display changes momentarily to REQUEST MADE to confirm your request was sent.

Fire Drill

Fire Drill is used to test the fire bells or fire horns in your system. The Fire Drill test turns your system bell circuit on, but does not send a message to the central station.

Starting a Fire Drill test

1. Access the User Menu.
2. Press COMMAND until FIRE DRILL? displays. Press any Select key.
3. The keypad displays SURE? YES NO.
4. Press the Select key under YES to start the Fire Drill test.

Ending a Fire Drill test

1. Enter your code at the keypad and press COMMAND to end the Fire Drill.
2. The Fire Drill test automatically ends with ALARM SILENCE or the programmed Bell Cutoff time.

Appendix A

About the Display Events Section

This section of the User's Guide shows the Display Events items. While in the Display Events function, use the COMMAND and Back Arrow keys to go forward or backward through the list of events.

The system memory holds a maximum of 12,000 past events for 45 days. Any event older than 45 days automatically clears from the system memory. Also, once the full 12,000 events are stored, any new event causes the oldest event to be cleared. See Appendix A for Display Events.

To view more information about each display, press the Select key as directed in the explanations.

Using the Display Events

1. Access the User Menu.
2. Press the COMMAND key until DISPLAY EVENTS? displays. Press any Select key.
3. The keypad displays FRST LST PRT SRT. Select FRST (first) to view the oldest to newest events. Select LST (last) to view the newest to oldest events. If you select FIRST, use the COMMAND key to scroll up through the events. If you select LAST, use the Back Arrow key to scroll down through the events.
Select SRT to sort through the Display Events log and collect information specific to a user or system event.
Select PRT to print the complete Display Events log.
4. To use the Sort feature, press the Select key under SRT. The keypad displays FRST DATE: 8/21. Press any Select key and enter a 4-digit beginning date for the sort. Press COMMAND.

5. The keypad displays LAST DATE: 10/17. Press any Select key and enter a 4-digit ending date for the sort. Press COMMAND.
6. The keypad displays USER NUMBER: -. To sort events for a particular user, enter their user number or press COMMAND to sort for all users. To search for a user, press any Select key then use the COMMAND and Back Arrow keys to browse through the user names in the system. When the user you want displays, press any Select key then press COMMAND.
7. The keypad next displays five event types that you can include in the sort. Press the fourth Select key to display YES as the event type name displays on the keypad. Press COMMAND. The following are the five sort event types:
ACCESSES = door accesses granted.
DOOR NUMBER = leave blank for all doors.
Note: If you select yes for access then only Door Access Granted Events are included in the sort.
ZONE EVENTS = zone alarms, troubles, and restorals.
USER EVENTS = adding, deleting, and changing user codes.
SUPERVISORY = system hardware problems and door access denied events.
8. After the last event type displays, the keypad again displays FRST LST PRT SRT. You can now view or print the sorted Display Events or press SRT to define a new sort.

Zone Event Displays

This displays alarms, troubles, and other events that may occur on your protection zones.

32-Character Display

ALR	10:23P	10/17
BASEMENT DOOR		

Description

An alarm occurred at 10:23 PM on Oct. 17. Press any Select key to see the zone number and zone type.

Zone Type - There are seven possible zone types you may see here.

FIRE - Fire **PANC** - Panic **BURG** - Burglary

EMRG - Emergency **SUPV** - Supervisory

AUX1 - Auxiliary 1 **AUX2** - Auxiliary 2

Event Types - There are seven event type you may see here:

ALR - Alarm **TBL** - Trouble **RST** - Restore

FLT - Zone Fault **SVC** - Service smoke detector

LOW - Low battery **MIS** - Missing wireless transmitter

Note: LOW and MIS are for wireless systems only.

User Code Change Event Displays

This displays any addition, deletion, or change to a user code.

32-Character Display

ADD	11:41A	10/ 17
U:19	BY	U:12

Description

User 19 added by user 12 at 11:41 AM. Press the Select key under either user (US:) number for the user name.

User Code Event Types - There are three event type you may see here:

ADD - User added **DEL** - User deleted

CHG - User code or authority level changed.

Supervisory Event Displays

This displays the date and time of an automatic test report.

32-Character Display

MSG 11:58P 10/ 17 AUTO RECALL

Description

The test report was sent to the central station at the date and time shown.

System Monitor Event Displays

This displays any problems with the system AC power, battery, or phone line(s), or any opening of a tampered panel box.

32-Character Display

TBL 11:41A 10/ 17 POWER

Description

An AC failure occurred at 11:41 AM. on Oct. 17.

System Monitor Event Types - There are 2 event types:

TBL - Trouble

RST - Restore

System Monitor Event Names - There are 5 system monitors:

POWER - AC power to panel

BATTERY - On panel

LINE 1 - Phone line number 1

LINE 2 - Phone line number 2

TAMPER - On panel box

Appendix B

Zone Status Browser

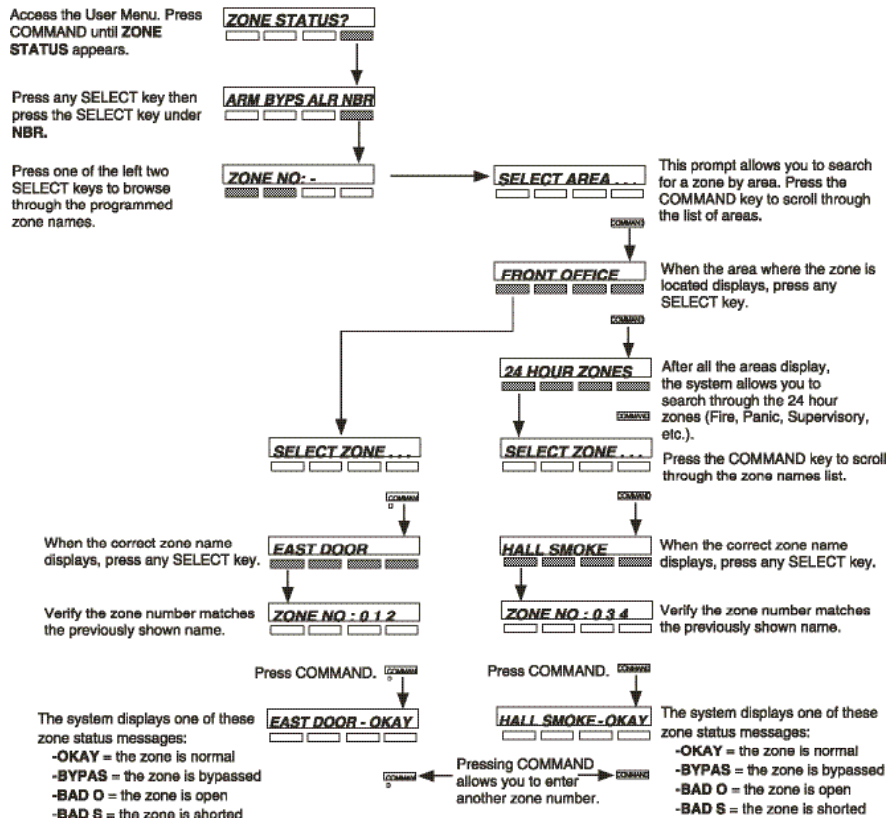

Outputs On/Off Browser

OUTPUTS ON/OFF?
OUTPUTS DOOR

Access the User Menu. Press the COMMAND key until **OUTPUTS ON/OFF?** displays. Press the Select key under **OUTPUTS** or **DOOR**.

OUTPUT: - ON OFF
DOOR: - ON OFF

Press either of the two left SELECT keys.

SELECT OUTPUT ...
SELECT DOOR ...

This prompt allows you to search for a door or an output. Press the COMMAND key to scroll through the list of doors or output names.

OFFICE FRONT DR

When the door or output you want displays, press any Select key.

OUTPUT: 127 ON OFF
DOOR: 128 ON OFF

The display shows the door or output number.

Output Groups Browser

OUTPUT GROUP: -

Access **OUTPUT GROUP: -** in the **USER PROFILES?** menu. Press any Select key.

SELECT GROUP ...

At this prompt you can scroll through the list of output group names.

SELECT ZONE ...

Press **COMMAND**.

The first output group name displays.

SELECT ZONE ...

Press **COMMAND**.

The next output group name displays.

FRONT OFFICE

Press any Select key and the output group number displays.

Change User Profiles Browser

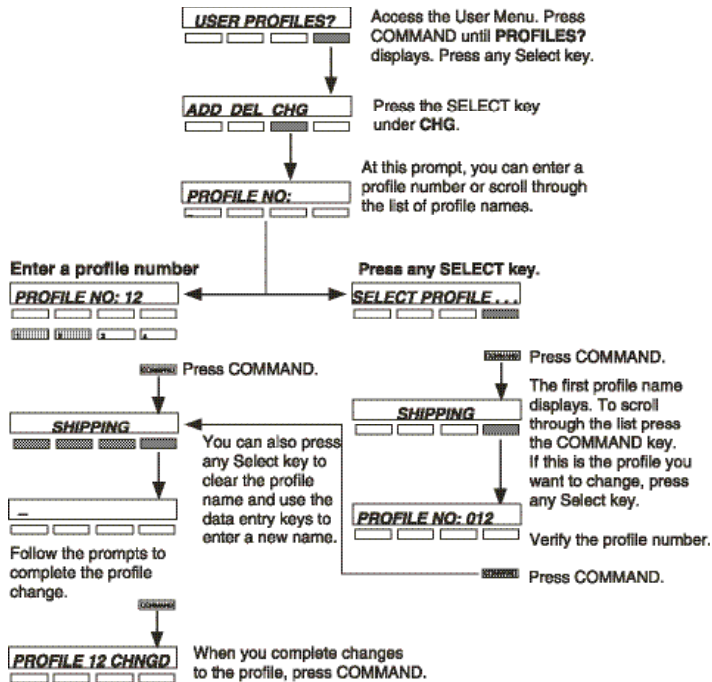

Add User Codes Browser

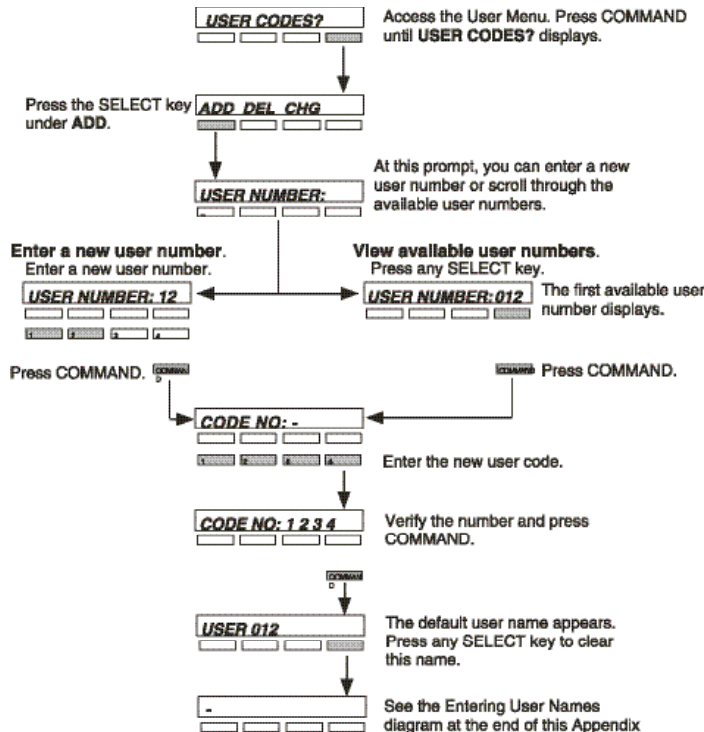

Delete User Codes Browser

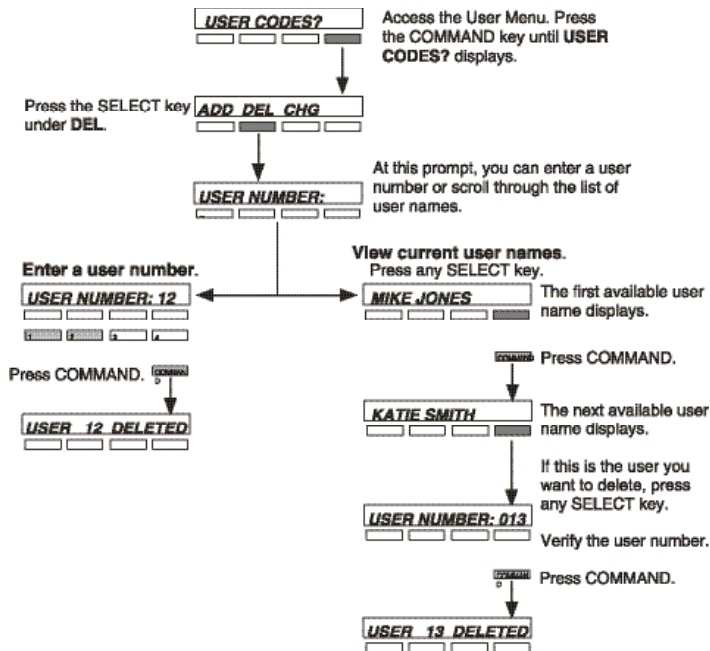

Change User Codes Browser

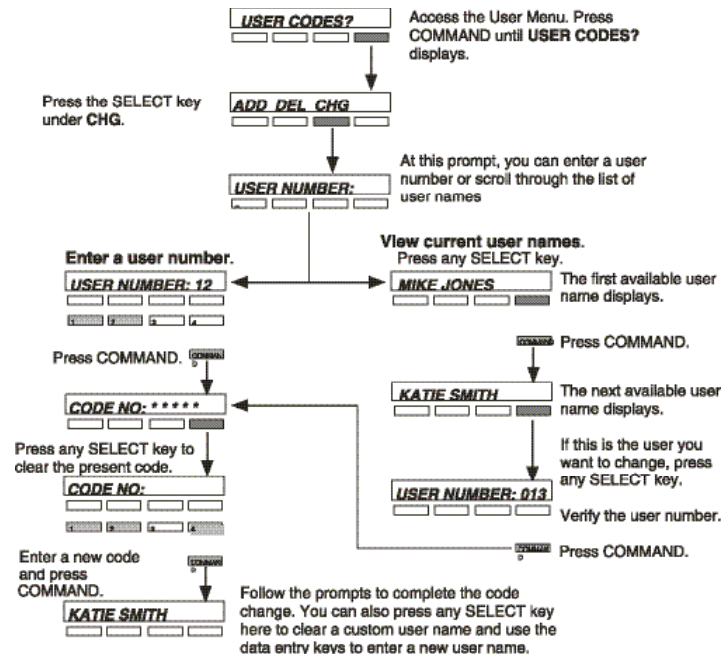

Entering User Names

1
To enter a custom name into the keypad, you use the three rows of number keys.

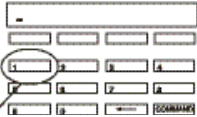

2
Under each number key are three letters. To enter a custom name, press the number key above the letter you want to enter.

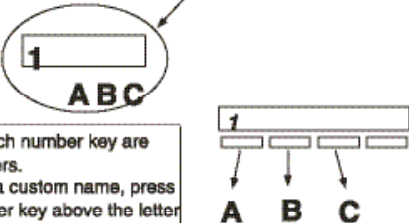

3
With the number displayed, press the SELECT key that matches the position of the letter. See example.



4
Once the letter you want displays, press the number key above the next letter you want to enter.

You can enter up to 16 characters for each name into the keypad.

The nine and zero keys . . .

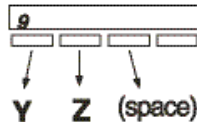

Y Z (space)

Pressing the 9 key provides you with Y, Z, and a space to use between names. For example: BOB SMITH.

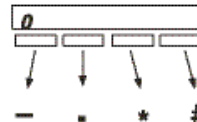

- . * #

Pressing the 0 (zero) key provides you with a - (dash), . (period), * (asterisk), and a # (pound sign).

Appendix C

Common Keypad Displays

Listed below are several keypad messages you may see on the display. Follow the instructions in the Possible Solutions column to correct the problem. In many cases, you need to call a service person to correct the problem. Displays that are not discussed here mean that your service representative should be called.

Message	Meaning	Possible Solutions
INVALID AREA	The user has attempted a door access to an area they are not assigned.	Change the user access areas if access to the area is needed. If access is not needed, the user cannot enter the area.
INVALID CODE	The user code you entered is not recognized by the system.	Check the user code and try again.
INVALID PROFILE	A user has attempted a function that is outside of the assigned profile.	Check the user profile settings.
INVALID TIME	A user code assigned to a specific schedule was entered outside of the valid schedule.	See Schedules and User Codes. Check the system clock.
ENTER 2ND CODE	The area you are attempting to disarm or access is a Two Man Area.	A second and different user code must be entered.
CLOSING TIME!	The scheduled has expired and in a short time the area will automatically arm.	Users still on the premise should arm the system or extend the schedule to a later time.
LATE TO CLOSE	The system was not armed at its scheduled closing time.	Users still on the premise should arm the system or extend the schedule to a later time.
FAILED TO EXIT	A user assigned the anti-passback option has attempted to re-enter an area from which they did not exit properly.	The user must exit the area through the proper door. If not possible, your system administrator should select the Forgive option in the User Codes menu.

Index

A

Add User Codes 15
 Browser 23

ALARM 5

 Cancelled 5
 Not Sent 5

ALARM LED 2

Alarm Silence 8

Ambush Codes 17

Anti-Pass Back 5, 14

Area Display 3

Armed Areas 5

Asterisks 3

B

Back Arrow key 2

Browser

 Add User Codes 23
 Change User Codes 24
 Change User Profiles 23
 Delete User Codes 24
 Outputs On/Off 22
 Output Groups 22
 Zone Status 21

C

Change User Codes 16
 Browser 24

Change User Profiles 13
 Browser 23

COMMAND key 2

D

Data Entry keys 2

Date and Time 16

Delete User Codes 15

 Browser 24

Displays

 ALARM 5

 Alarm Cancelled 5

 Alarm Not Sent 5

 Area 3

 Armed Area 5

 Device 3

 Enter Code 5

 Invalid Area 5

 Invalid Code 5

 Invalid Profile 5

 Invalid Time 5

 Multi-lingual Option 3

 Service Required 6

 Silenced 5

 Supervisory 5

 System Busy 6

 System Trouble 6

 Trouble 5

 Try Again 5

Display Events 17, 18

 Supervisory Event Displays 20

 System Monitor Event Displays 20

 User Code Change Event Displays 19

 Zone Event Displays 19

DRILL Key 4

E

Entering User Names 25

F

Failed to Exit 6

Fire Command Center 1, 2

 ALARM 5

 Back Arrow Key 2

 COMMAND key 2

 Data Entry Keys 2

 Function keys 4

 Select Keys 2

 Status LEDs 2

Fire Command Center Displays 5

Fire Command Center Tones

 Exit 6

 Fire Alarm 6

- Key Press 6
- Prewarn 6
- Trouble 6
- Fire Drill 17
- Function Keys 4
 - DRILL Key 4
 - RESET Key 4
 - SILENCE Key 4
 - TEST Key 4

I

- Invalid Area 5
- Invalid Profile 5
- Invalid Time 5

K

- Keypad Display Options 3
 - Asterisks 3
 - Current Programming 3
 - Multi-lingual 3

L

- LEDs 2
 - Alarm LED 2
 - Power LED 2
 - Trouble LED 2

M

- Multi-lingual Display 3

O

- Outputs On/Off 9
 - Browser 22
- Output Groups
 - Browser 22

P

- Panic Zone Test 12
- Profiles 12
 - Changing 13
- Programming
 - Current Keypad Display Options 3

R

- Re-Arm Delay 14
- Remote Annunciator Keypad 5
- Remote Fire Command Center 5

S

- Select keys 2
- Sensor Reset 8
- Service Request 17
- Service Required 6
- Shift Schedules 14
- Silence Alarm b
- Silenced 5
- Status LEDs 2
- System Busy 6
- System Status 11
- System Test 11

- System Trouble 6

T

- TEMP CODE 13
- Tones 6
 - Exit tone 6
 - Fire Alarm tone 6
 - Key press tone 6
 - Prewarn tone 6
 - Trouble tone 6
- TROUBLE LED 2

U

- User Codes 14
 - Adding 15
 - Changing 16
 - Deleting 15
 - Names 14
- User Menu 1, 7
- User Profiles 12
 - Anti-Pass Back 14
 - Re-Arm Delay 14
 - Shift Schedules 14
 - Temporary Code 13

Z

- Zone Status 10
 - Browser 21

This page intentionally left blank.

